

# WIRELESS ELECTRO-INSTALLATION



# ELKO EP



**We are traditional, innovative and purely Czech development manufacturer of electronic devices and we have been your partner in the field of electroinstallations for 27 years.**

ELKO EP employs about 274 people, exports its products to more than sixty six countries, and has representatives in eleven foreign branches. Company of the Year of the Zlín Region, Visionary of the Year, Global Exporter of the Year, Participation in the Czech TOP 100, these are just some of the awards received. Still, we are not finished. We are constantly striving to move forward in the field of innovation and development. That's our primary concern.

Millions of relays, thousands of satisfied customers, hundreds of our own employees, twenty seven years of research, development and production, eleven foreign branches, one company. ELKO EP, innovative- a purely Czech company based in Holešov, where development, production, logistics, service and support go hand in hand. We primarily focus on developing and manufacturing systems for building automation in the residential, commercial and industrial sector, a wide range of Smart city facilities and the so-called Internet of Things (IoT).



# Facts and stats

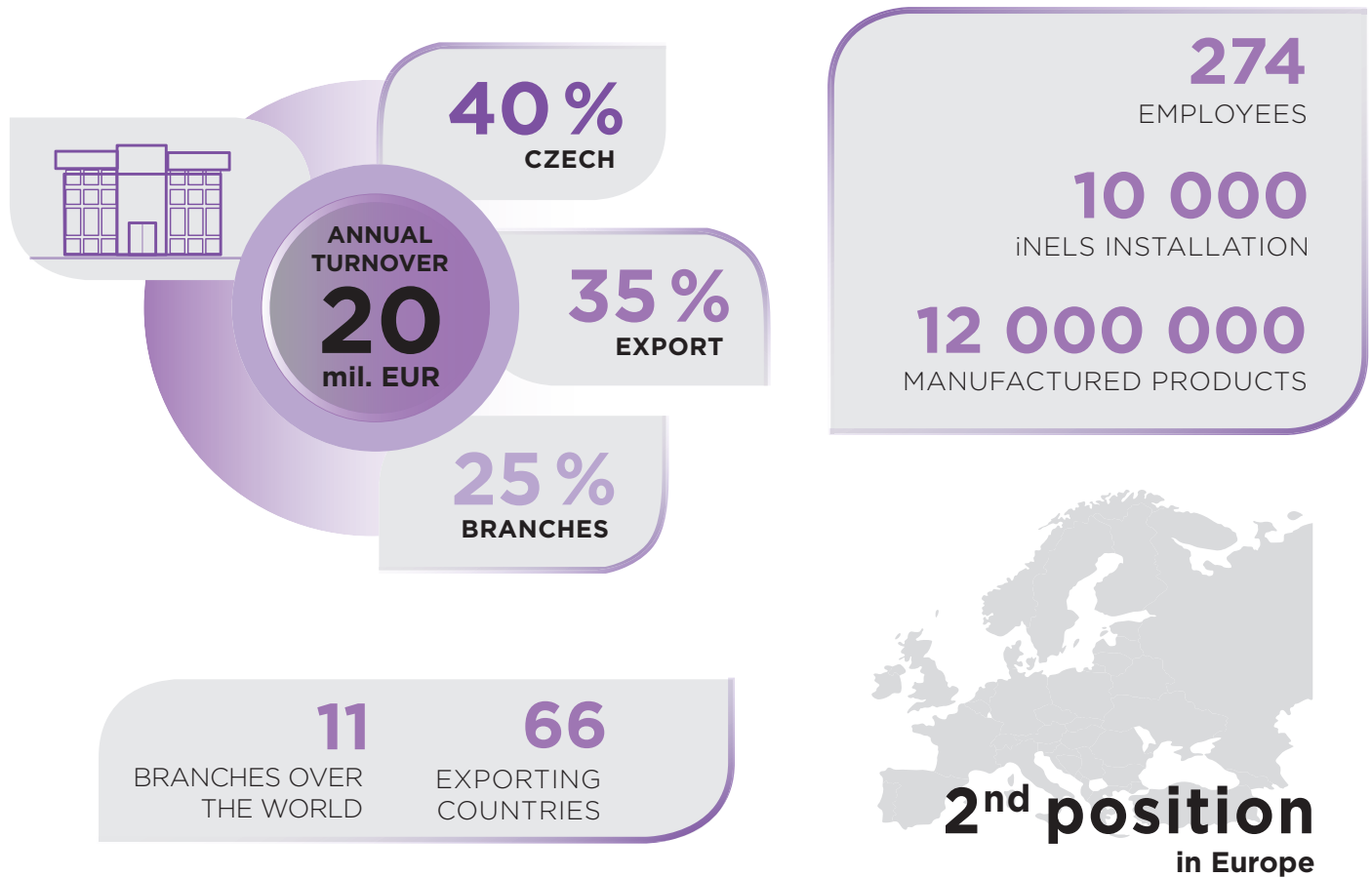

## WE ARE

 <p><b>DEVELOPERS</b></p> <p>In the new R&amp;D center, more than 30 engineers develop new products and extend the functionality of existing products.</p>	 <p><b>PRODUCERS</b></p> <p>modern antistatic spaces, 2x fully automated SMD production lines, 2 shift operations.</p>	 <p><b>SUPPORT</b></p> <p>24 hours / 7 days / 360 days we not only provide technical support but also logistics.</p>	 <p><b>SELLERS</b></p> <p>personal access to more than 70 sales representatives in ELKO EP Holding provides impeccable services and superior products at an affordable price.</p>
---	---	---	--

## CLASSIC ELECTRO-INSTALLATION

[www.elkoep.com/relay-modular-electronic-devices](http://www.elkoep.com/relay-modular-electronic-devices)

Electricity is our everyday guide. In our range you will find electronic modular devices from time relays to thermostats. We build on solid foundations and have been developing and manufacturing for more than 27 years.

**Price:** Savings:

		<input checked="" type="checkbox"/> Controlling appliances	<input checked="" type="checkbox"/> Dimming lights	<input checked="" type="checkbox"/> Controlling blinds	<input checked="" type="checkbox"/> Heating regulation	 Wireless controller	 Detectors	 Smartphone Smart watch	 Touch panel
		 Controlling household appliances	 Door communicator	 Weather station	 Video cameras (outdoor/indoor)	 Audio Zone (music playback)	 PC/Laptop	 Tablet	 Video Zone (controlling via TV)

## WIRELESS ELECTRO-INSTALLATION

[www.elkoep.com/rf-control](http://www.elkoep.com/rf-control)

An ideal solution for completed houses, when it is no longer possible to intervene in the structure. Communication works wirelessly through the central brain, the RF Touch unit. From this unit you control thermostats and can control up to a range of 200 m.

**Price:** Savings:

		<input checked="" type="checkbox"/> Controlling appliances	<input checked="" type="checkbox"/> Dimming lights	<input checked="" type="checkbox"/> Controlling blinds	<input checked="" type="checkbox"/> Heating regulation	<input checked="" type="checkbox"/> Wireless controller	<input checked="" type="checkbox"/> Detectors	<input checked="" type="checkbox"/> Smartphone Smart watch	<input checked="" type="checkbox"/> Touch panel
		 Controlling household appliances	 Door communicator	 Weather station	 Video cameras (outdoor/indoor)	 Audio Zone (music playback)	 PC/Laptop	 Tablet	 Video Zone (controlling via TV)

## WIRED ELECTRO-INSTALLATION

[www.elkoep.com/inels-bus](http://www.elkoep.com/inels-bus)

If you are building a new house, this electrical installation is tailor-made for you. The data wire (bus) is routed in the walls through the entire house. The advantage is the possibility of expansion with a multimedia superstructure or connection of third parties (appliances, cameras, etc.)

**Price:** Savings:

		<input checked="" type="checkbox"/> Ovládání spotřebičů	<input checked="" type="checkbox"/> Dimming lights	<input checked="" type="checkbox"/> Controlling blinds	<input checked="" type="checkbox"/> Heating regulation	<input checked="" type="checkbox"/> Wireless controller	<input checked="" type="checkbox"/> Detectors	<input checked="" type="checkbox"/> Smartphone Smart watch	<input checked="" type="checkbox"/> Touch panel
		<input checked="" type="checkbox"/> Controlling household appliances	<input checked="" type="checkbox"/> Door communicator	<input checked="" type="checkbox"/> Weather station	<input checked="" type="checkbox"/> Video cameras (outdoor/indoor)	<input checked="" type="checkbox"/> Audio Zone (music playback)	<input checked="" type="checkbox"/> PC/Laptop	<input checked="" type="checkbox"/> Tablet	<input checked="" type="checkbox"/> Video Zone (controlling via TV)

It does not matter what you control, but how easily you control it. With us you can control the devices and appliances in many ways, one at a time or combine them at will.

For those conservatives amongst us, there are buttons in the form of switches exactly as we know and are used to them, for those of

us who often move around the house In the garden, the RF Pilot remote control in your pocket will surely be appreciated. Touch unit is again designed for those who like everything in one place with a – 3.5 „display securely holding all the necessary buttons within the frame. An interesting and often preferred option is the driver’s smartphone – which most of us already have in our pocket.

**YOU CAN CONTROL iNELS WITH:**

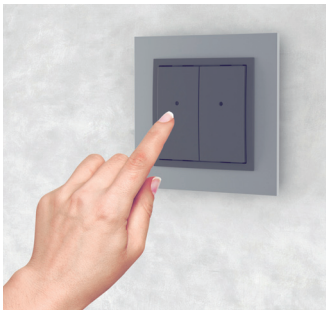

**Wireless wall controller**

- 2 or 4 buttons
- simple installation – can be attached or fixed anywhere
- in LOGUS<sup>90</sup> design (natural materials and colour combinations)



**Glass wall controller**

- wall controller in elegant glass design
- 2 or 4 buttons
- two side tape installation or wall box installation
- signal range up to 200 m

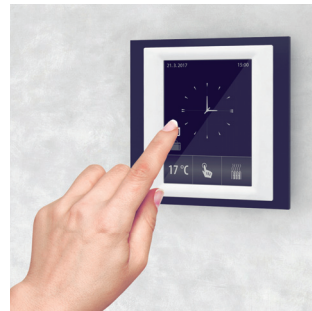

**Wireless touch unit RF Touch**

- wireless touch unit for wall box installation
- it will become a central, wireless intuitively controlled home
- coloured 3,5" TFT display



**Keychain**

- 4 button controller
- pocket controller for every day
- in colour white or black

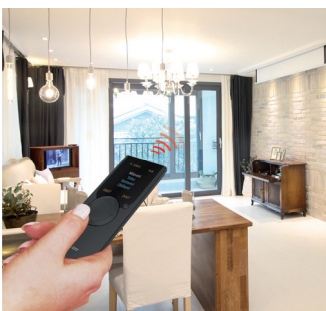

**Wireless remote controller with display**

- here marks the start of home automation
- the remote controller with OLED colour display offers control of up to 40 household appliances
- lights, sockets, garage doors, sprinklers, blinds, awnings, etc.



**Smartphone**

- the only controller that comes free
- your home under control thanks to Android application
- you no longer have to worry about unpleasant surprises after downloading the Android or iOS application for free

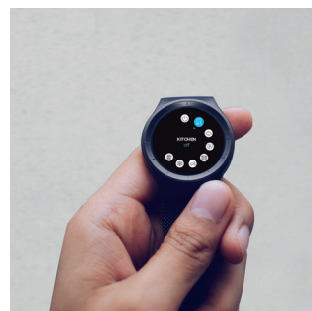

**Smart watch**

- the only controller that comes free
- your home under control thanks to Android application
- you no longer have to worry about unpleasant surprises after downloading the Samsung Gear app



**Smart TV SAMSUNG**

- first application in the world for controlling iNELS in Samsung TV
- free download on Samsung Hub
- comfortably control not only the elements in individual rooms, but also outdoor cameras

## Wireless control system

Overview of wireless system units .....	8
iNELS Wireless System .....	12
<b>Controllers</b>	
RFWB-20/G, RFWB-40/G   On-wall button controller .....	15
RFGB-20/W, RFGB-20/B, RFGB-40/W, RFGB-40/B   Glass touch controllers SHARP - <b>NEW!</b> .....	16
RFGB-220/W, RFGB-220/B, RFGB-240/W, RFGB-240/B   Glass touch controller ROUND - <b>NEW!</b> .....	17
RFDW-71/W, RFDW-71/B   Glass touch controller with dimmer SHARP - <b>NEW!</b> .....	18
RFDW-271/W, RFDW-271/B   Glass touch controller with dimmer ROUND - <b>NEW!</b> .....	19
RF KEY/W, RF KEY/B   Keychain - 4 buttons .....	21
RF Pilot/W, RF Pilot/B   Remote RF controller with display .....	22
<b>Switches</b>	
RFSA-11B, RFSA-61B   Switch unit, 1 channel – (BOX) .....	24
RFSA-62B   Switch unit, 2 channels – (BOX) .....	25
RFSAI-62B   Switch unit, 2 channels with external inputs – (BOX) .....	26
RFJA-32B   Switch unit for shutters – (BOX) .....	27
RFSA-61M, RFSA-66M   Switch unit, 1 channel – (1/6 modul DIN) .....	28
RFUS-61   Switch unit, 1 channel, increased housing protection IP65 .....	29
RFSC-61   Switching socket-plug, 1 channel .....	30
<b>Dimmers</b>	
RFDEL-71B   Universal dimmer – (BOX) .....	31
RFDAC-71B   Analog controller – (BOX) .....	32
RFDEL-71M   Universal dimmer – (1 modul DIN) .....	33
RFDA-73M/RGB   Three channels dimmer for LED (RGB) strips – (3 modul DIN) .....	34
RFDS-71   Dimming socket-plug .....	36
<b>Temperature control</b>	
RFTC-10/G   System temperature controller – (LOGUS <sup>90</sup> ) .....	37
RFTC-50/G   Autonomous temperature controller – (LOGUS <sup>90</sup> ) .....	38
RFSTI-11B   Switch unit with a external temperature sensor – (BOX) .....	39
RFTI-10B   Temperature sensor – (BOX) .....	40
TC, TZ   Temperature sensors .....	41
RFATV-1   Wireless thermovalve .....	42
TELVA 230 V, TELVA 24 V   Thermodrive .....	43
<b>Converters</b>	
RFIM-20B, RFIM-40B   Input contacts converter (BOX) .....	44
RFSG-1M   Input contact converter (1 modul DIN) .....	45
<b>Detectors</b>	
RFSF-1B   Level switch (BOX) .....	46
FP-1   Liquid probe .....	46
RFSF-100   Flood detector .....	47
RFSOU-1   Twilight switch (IP65) .....	48

RFMD-100   Motion detector .....	49
RFSD-100, RFSD-101   Smoke detector .....	50
RFWD-100   Window/door detector .....	52
<b>System units</b>	
RF Touch   Wireless touch unit .....	54
RFRP-20   Repeater (socket) .....	56
eLAN-RF-003   Smart RF box .....	57
Applications .....	58
Voice control .....	59
<b>Energy management</b>	
RFPM-2M   Energy gateway (3-modul DIN) .....	60
RFTM-1   Pulse converter .....	62
CT50   Current transformer .....	63
LS, MS, WS   Sensors for RFTM-1 .....	63
<b>Hotel Retrofit (HRESK)</b>	
RFTC-150/G   Temperature controller (LOGUS <sup>90</sup> ) .....	67
RFPCR-31/G   Multifunctional card reader (LOGUS <sup>90</sup> ) .....	68
RFGCR-31/W, RFGCR-31/B   Multifunctional card reader (glass) .....	69
RFGCH-31/W, RFGCH-31/B   Smart Card Holder (glass) .....	70
RFTSI-111B   Switch unit with external temperature sensor (BOX) .....	71
RFSAI-161B   Switch unit, 1 channel with external input for local (existing) switch (BOX) .....	72
RFSA-166M   Six channel switch unit for fancoil (3-modul DIN) .....	74
<b>Accessories</b>	
RFAF/USB   Service Key .....	75
AN-I, AN-E   Internal antenna .....	75
Supported video cameras, Intercoms .....	76
RF Sets .....	77
<b>Overview of functions</b>	
Swiches .....	78
Dimmers .....	79
Protol and capatibility .....	80
Installation .....	81
Product dimension .....	82
EAN codes .....	86

## Controllers

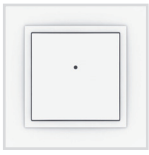
**RFWB-20/G**

On-wall button controller  
- 2 buttons

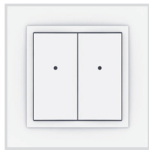
**RFWB-40/G**

On-wall button controller  
- 4 buttons

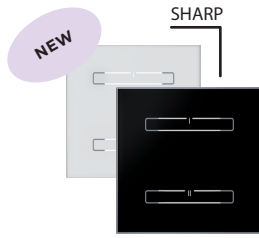

**RFGB-20/W** - white glass  
**RFGB-20/B** - black glass  
Glass touch controller  
- 2 buttons, SHARP

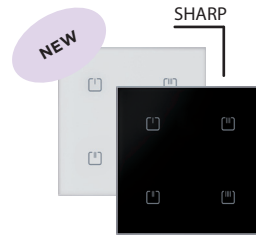

**RFGB-40/W** - white glass  
**RFGB-40/B** - black glass  
Glass touch controller  
- 4 buttons, SHARP

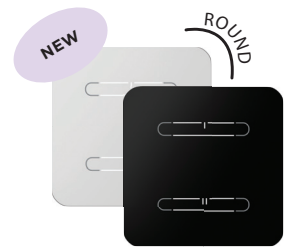

**RFGB-220/W** - white glass  
**RFGB-220/B** - black glass  
Glass touch controller  
- 2 buttons, ROUND

## Switches

**RFSA-11B**

Switch unit, 1x 16 A  
single function

**RFSA-61B**

Switch unit, 1x 16 A  
multi-function

**RFSA-62B**

Switch unit, 2x 8 A  
multi-function

**RFSAI-62B**

Switch unit, 2x 8 A with  
external inputs  
- multi-function

**RFJA-32B**

Switch unit for shutters  
- 2x 8 A

## Dimmers

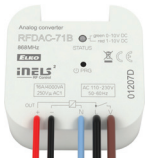
**RFDAC-71B**

Analog controller, 0(1)-10 V  
- multi-function

**RFDEL-71B**

Universal dimmer  
- 1x 160 VA  
- R, L, C, LED, ESL

**RFDEL-71M**

Universal dimmer  
- 1x 600 VA  
- R, L, C, LED, ESL

**RFDA-73M/RGB**

Three channels dimmer  
for LED (RGB) strips

**RFDSC-71**

Dimming socket-plug  
- 1x 300 VA  
- R, L, C, LED, ESL

## Temperature control

**RFTC-10/G**

System temperature  
controller

**RFTC-50/G**

Autonomous temperature  
controller

**RFSTI-11B**

Switch unit with an external  
temperature sensor

**RFTI-10B**

Temperature sensor  
(internal + external)

**TC TZ**

Temperature sensor

## Lighting

**RFIM-20B**

Input contacts converter  
- 2x permanent contacts

**RFIM-40B**

Input contacts converter  
- 4x instantaneous contacts

**RFSG-1M**

Input contact converter  
- 1x permanent or  
instantaneous contact



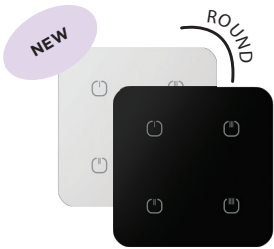

**RFGB-240/W** - white glass  
**RFGB-240/B** - black glass  
 Glass touch controller  
 - 4 buttons, ROUND

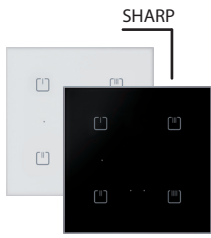

**RFDW-71/W** - white glass  
**RFDW-71/B** - black glass  
 Glass touch controller  
 with dimmer, SHARP



**RFDW-271/W** - white glass  
**RFDW-271/B** - black glass  
 Glass touch controller  
 with dimmer, ROUND



**RF Key/W** - white  
**RF Key/B** - black  
 Keychain  
 - 4 buttons



**RF Pilot/W** - white  
**RF Pilot/A** - anthracite  
 Remote RF controller with  
 display



**RFSA-61M**  
 Switch unit, 1x 16 A  
 - multi-function



**RFSA-66M**  
 Switch unit, 6x 8 A  
 - multi-function



**RFUS-61**  
 Switch unit, 1x 12 A  
 - multi-function



**RFSC-61**  
 Switching socket plug,  
 - 1x 16 A, multi-function



**RFATV-1**  
 Wireless thermostatic valve



**Telva**  
 Thermostatic  
 ON/OFF, 0-10V

## Detectors



**RFSF-1B**  
Level switch



**FP-1**  
Liquid probe



**RFSF-100**  
Flood detector



**RFSOU-1**  
Twilight switch



**RFSD-100**  
Smoke detector

## System units



**RF Touch-B**  
Wireless touch unit  
– an installation box  
– surface mounted



**RF Touch-W**



**eLAN-RF-003**  
Smart RF box



**RFRP-20**  
Repeater to extend  
the range



**RFPM-2M**  
Energy gateway



**RFTM-1**  
Pulse converter



**CT50**  
Current transformer



**LS**  
LED sensor for  
RFTM-1 (pulse  
converter)

**MS**  
Magnetic sensor  
for RFTM-1 (pulse  
converter)

**WS**  
Magnetic sensor  
water meter for  
RFTM-1 (pulse  
converter)

## Hotel Room Energy Saving Kit



**RFTC-150/G**  
Temperature  
controller



**RFPCR-31/G**  
Multifunctional card  
reader

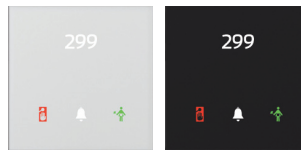

**RFGCR-31/W** - white glass  
**RFGCR-31/B** - black glass  
Multifunctional card reader

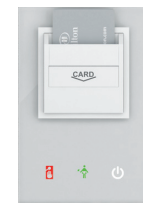

**RFGCH-31/W** - white glass  
**RFGCH-31/B** - black glass  
Smart Card Holder

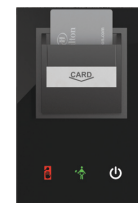

**RFSAI-161B**  
Switch unit with  
external input

## Příslušenství



**RFAF/USB**  
Service Key



**AN-I**  
Internal antenna  
sensitivity 1 dB



**AN-E**  
External antenna  
sensitivity 5 dB



**RFSD-101**  
Smoke detector  
(+ temperature + humidity  
+ lighting)



**RFWD-100**  
Window/Door detector



**RFMD-100**  
Motion detector



**RFSTI-111B**  
Switch unit with external  
temperature sensor



**RFSA-166M**  
Six channel switch unit  
for fancoil

**Supported video cameras**



Axis



D-Link



HIK VISION

**Supported intercoms**



2N



HIK VISION



DAHUA

# iNELS RF Control Wireless System

 RF - radiofrequency protocol

 Wi-Fi

 LAN

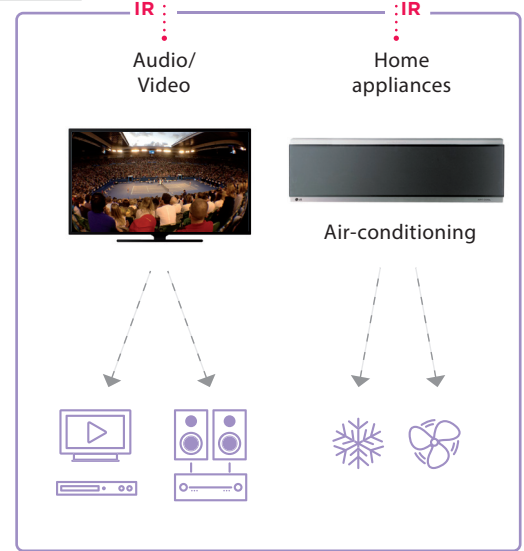
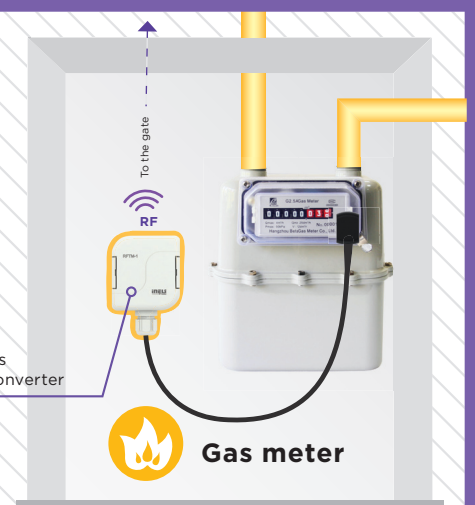
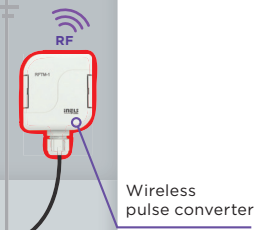
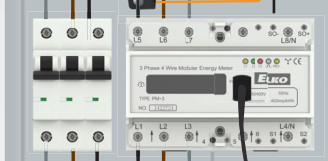
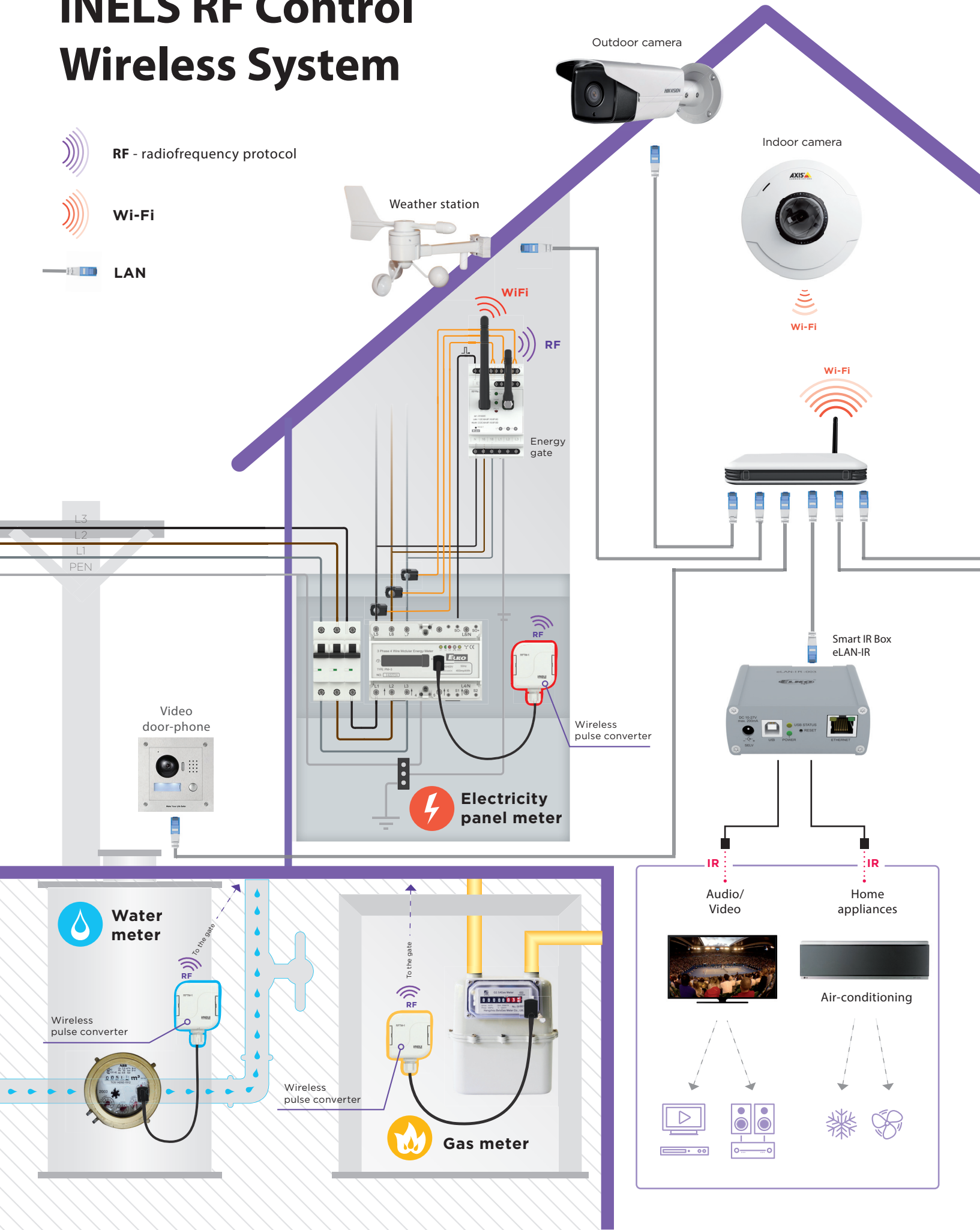

**External Controllers:**

Smartphone      PC application      Samsung Smart TV application      Voice assistants (Amazon Alexa, Google Home)      Smart watch

**Internal Controllers:**

Radio & Intercom      Touch unit      Wall controller      Glass controller      Thermostat      Wireless dimmer switch      RF Pilot / Keychain

Smart RF Box eLAN-RF

**Detectors:**

Smoke      Door/window      Motion      Flood

**Sensors:**

Temperature      Twilight

**Elements:**

Switch unit - 6 outputs      Switch unit to installation box      Switching socket      Switch unit for shutters      Thermovalve for radiator      Switch unit - 1 channel      Dimmer for LED strips

**iNELS**<sup>®</sup>  
RF Control



**The wireless iNELS RF system offers you a unique chance to breathe life into your home.**

Controlling appliances, dimming lights, creating light scenes, security - we need all these functions in our daily lives. iNELS RF is a building kit that you build just the way you like. The result will be one system that takes complete care of the running of your home. It will become an indispensable part of your family. You can fully adjust iNELS based on what you do or where you are, whether on vacation or at work, with family at home or with friends, or whether you are waking up or going to sleep.

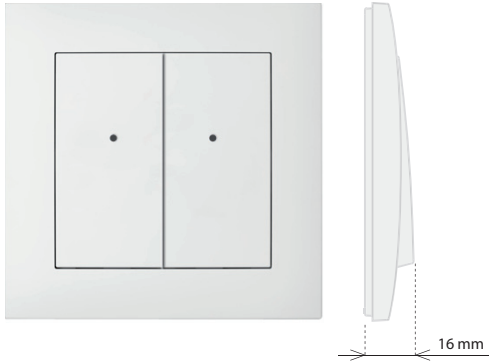

- On-wall button controller is used to control switches and dimmers (lights, gate, garage door, blinds, etc.).
- **RFWB-20/G:** two buttons enable control of two units independently.
- **RFWB-40/G:** four buttons enable control of four units independently.
- The flat design with level base makes it ideal for fast installation on any surface (fixation with adhesive or screws in the installation box).
- When pressing the button, it sends a set signal (ON/OFF, dimming, time switching OFF/ON, blinds up/down).
- Sending a command is indicated by a red LED.
- In LOGUS<sup>90</sup> switch frame design (plastic, glass, wood, metal, stone).
- Option of setting light scenes, where with a single press, you can control units of iNELS RF Control.
- Battery power supply (3 V CR 2032 battery - included in the supply) with battery life of around 5 years based on frequency of use.
- Range up to 200 m (in open space), if the signal is insufficient between the controller and unit, use the signal repeater RFRP-20 or protocol component RFIO2 that support this feature.
- Communication frequency with bidirectional protocol RFIO.

Technical parameters	RFWB-20/G	RFWB-40/G
Supply voltage:	3 V CR 2032 battery	
Battery life:	around 5 years based on frequency of use	
Transmission indication	red LED	
Number of buttons:	2	4
Communication protocol:	RFIO	
Frequency:	866–922 MHz (for more information see p. 80)	
Signal transmission method:	unidirectionally addressed message	
Range:	in open space up to 200 m	
<b>Other data</b>		
Operating temperature:	-10 to +50 °C	
Operating position:	any	
Mounting:	glue/screws	
Protection:	IP20	
Contamination degree:	2	
<b>Dimensions frame</b>		
- plastic:	85 x 85 x 16 mm	
- metal, glass, wood, granite:	94 x 94 x 16 mm	
Weight (plastic):*	38 g	39 g
Related standards:	EN 60669, EN 300 220, EN 301 489 R&TTE Directive, Order. No 426/2000 Coll. (Directive 1999/EC)	

Device description

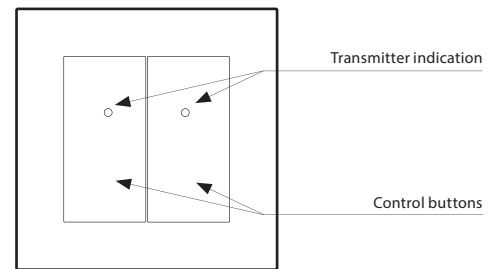

\* Comes with plastic frame. No installation into multi-frames.

RFWB-40/G

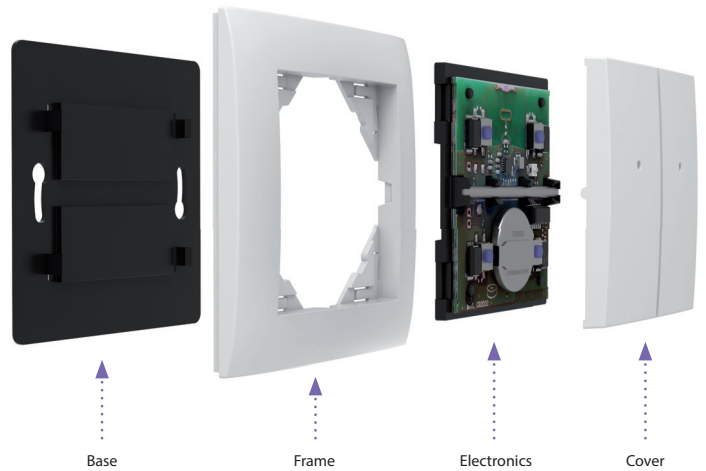

LOGUS<sup>90</sup>

Choose your own style

Flat wireless switches that can be mounted on glass, tile, furniture ... Such a quick change of location when you're moving.



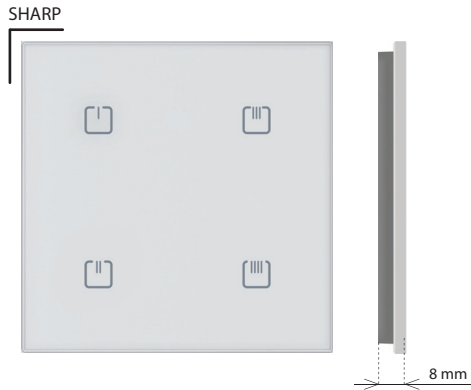

- The glass touch controller is a design RF (wireless) Control unit and is available in elegant black and white variants.
- Only 8 mm thick.
- **RFGB-20:** 2 capacitive buttons allows to control 2 devices.
- **RFGB-40:** 4 capacitive buttons allows to control 4 devices.
- When pressing the button, it sends a set signal (ON/OFF, dimming, time switching OFF/ON, blinds up/down). Sending a command is indicated by a red LED.
- Option of setting light scenes, where with a single press, you can control units of iNELS RF Control.
- The rear base allows to be attached to installation using screws, double-sided tape or keeping controller on the table.
- Battery power supply (2x 3 V CR 2032 batteries - included in the supply) with battery life of around 2 years based on frequency of use.
- Range up to 200 m (in open space), if the signal is insufficient between the controller and unit, use the signal repeater RFRP-20 or protocol component RFIO2 that support this feature.
- Communication frequency with bidirectional protocol RFIO.

Technical parameters	RFGB-20	RFGB-40
Supply voltage:	2x 3 V CR 2032 batteries	
Battery life:	around 2 years based on frequency of use	
Transmission indication:	red LED	
Number of capacitive buttons:	2	4
Communication protocol:	RFIO	
Frequency:	866–922 MHz (for more information see p. 80)	
Signal transmission method:	unidirectionally addressed message	
Range:	in open space up to 200 m	
<b>Other data</b>		
Operating temperature:	-10 to +50 °C	
Operating position:	any	
Mounting:	glue/screws	
Protection:	IP20	
Contamination degree:	2	
Dimensions:	94 x 94 x 8 mm	
Weight:	122 g	122 g
Related standards:	EN 60669, EN 300 220, EN 301 489 R&TTE Directive, Order. No 426/2000 Coll. (Directive 1999/EC)	

### Device description

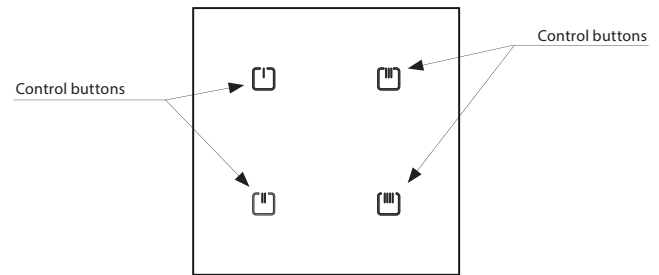

RFGB-40/W

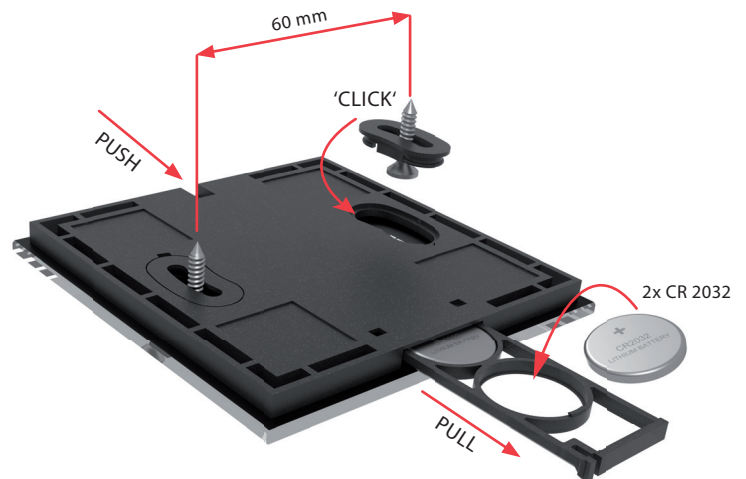
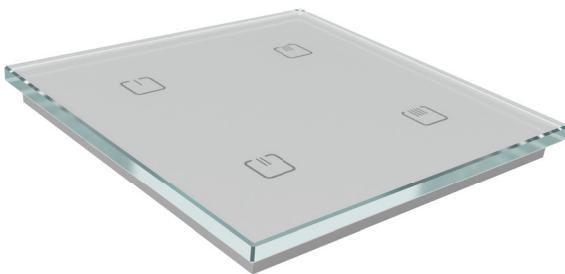

### Variants

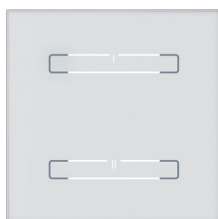

RFGB-20/W

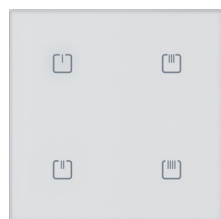

RFGB-40/W



RFGB-20/B

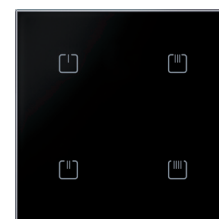

RFGB-40/B



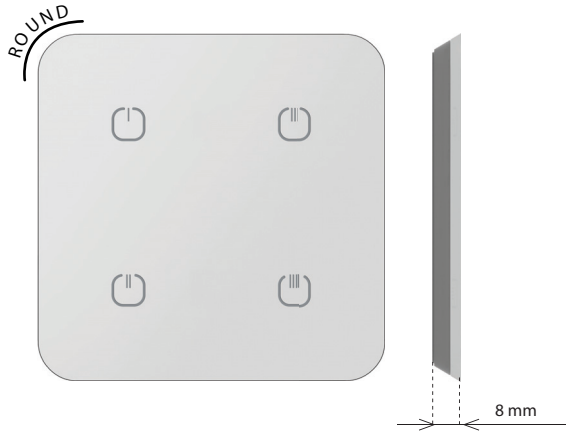

- The glass touch controller is a design RF (wireless) Control unit and is available in elegant black and white variants.
- Only 8 mm thick.
- **RFGB-220:** 2 capacitive buttons allows to control 2 devices.
- **RFGB-240:** 4 capacitive buttons allows to control 4 devices.
- When pressing the button, it sends a set signal (ON/OFF, dimming, time switching OFF/ON, blinds up/down). Sending a command is indicated by a red LED.
- Option of setting light scenes, where with a single press, you can control units of iNELS RF Control.
- The rear base allows to be attached to installation using screws, double-sided tape or keeping controller on the table.
- Battery power supply (2x 3 V CR 2032 batteries - included in the supply) with battery life of around 2 years based on frequency of use.
- Range up to 200 m (in open space), if the signal is insufficient between the controller and unit, use the signal repeater RFRP-20 or protocol component RFIO2 that support this feature.
- Communication frequency with bidirectional protocol RFIO.

Technical parameters	RFGB-220	RFGB-240
Supply voltage:	2x 3 V CR 2032 batteries	
Battery life:	around 2 years based on frequency of use	
Transmission indication:	red LED	
Number of capacitive buttons:	2	4
Communication protocol:	RFIO	
Frequency:	866–922 MHz (for more information see p. 80)	
Signal transmission method:	unidirectionally addressed message	
Range:	in open space up to 200 m	
<b>Other data</b>		
Operating temperature:	-10 to +50 °C	
Operating position:	any	
Mounting:	glue/screws	
Protection:	IP20	
Contamination degree:	2	
Dimensions:	100 x 100 x 8 mm	
Weight:	122 g	122 g
Related standards:	EN 60669, EN 300 220, EN 301 489 R&TTE Directive, Order. No 426/2000 Coll. (Directive 1999/EC)	

Device description

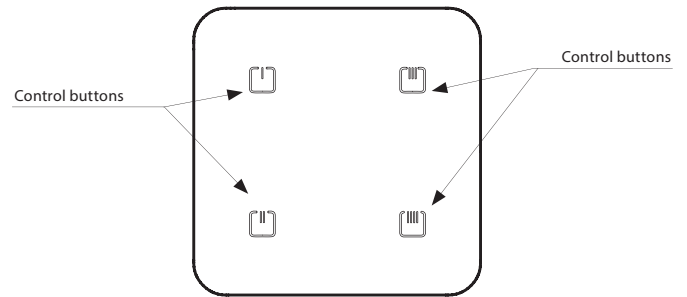

RFGB-240/W

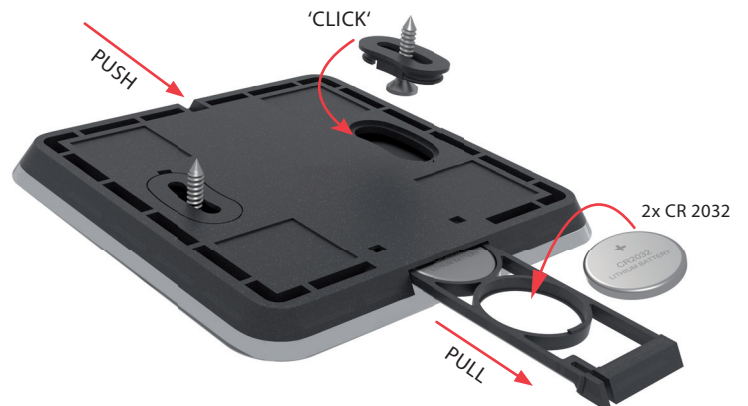

Variants



RFGB-220/W

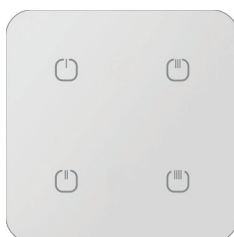

RFGB-240/W



RFGB-220/B

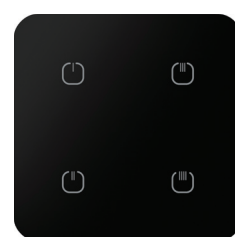

RFGB-240/B

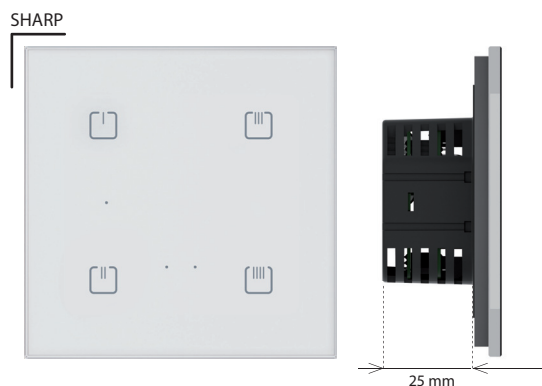

- Glass touch controller with integrated dimming component which serves to regulate light sources:
  - R – classic lamps (resistive load)
  - L – halogen lamps with wound transformer (inductive load)
  - C – halogen lamps with electronic transformer (capacity load)
  - ESL – dimmable energy-efficient fluorescent lamps
  - LED – LED light sources (230 V) equipped with LED.
- 4 channel switch version allows you to control the integrated dimmer as well as other components of the installation.
- They can be combined with detectors, controllers, iNELS RF Control or system components.
- 6 light functions - smooth increase or decrease with time setting 2 s - 30 min. Function description can be found on page 79.
- When switched off, the set level is stored in the memory, and when switched back on, it returns to the most recently set value.
- Thanks to setting the min. brightness by potentiometer, you will eliminate flashing of the LED and ESL light sources.
- The universal dimmer may be controlled by up to 25 channels.
- The programming button on the controller is also used for manual control of the output.
- Memory status can be pre-set in the event of a power failure.
- Range up to 160 m (in open space), if the signal is insufficient between the controller and unit, use the signal repeater RFRP-20 or protocol component RFIO2 that support this feature.
- Communication frequency with bidirectional protocol RFIO2.

Technical parameters	RFDW-71/230V	RFDW-71/120V
Supply voltage:	230 V AC / 50 Hz	120 V AC / 60 Hz
Apparent power:	1.1 VA	1.1 VA
Dissipated power:	0.8 W	0.8 W
Supply voltage tolerance:	±10 %	
Dimmed load:	R,L,C, LED, ESL	
<b>Input</b>		
Temperature measuring:	YES, built-in temperature sensor	
Scope and accuracy of temp. measurement:	0.. +55°C; 0.3°C from the range	
<b>Output</b>		
Contactless:	2 x MOSFET	
Load capacity:*	max. 160 W	max. 80 W
<b>Control</b>		
Wireless:	up to 25 channels (buttons)	
Communication protocol:	RFIO2	
Frequency:	866–922 MHz (for more information see p. 80)	
Repeater function:	yes	
Manual control:	4 touch keys, button PROG	
Indications touch keys:	red/green LED	
Indications PROG:	colour adjustable prog. mode	
Range:	in open space up to 160 m	
<b>Connection</b>		
Terminals:	0.5 - 1 mm <sup>2</sup>	
<b>Other data</b>		
Operating temperature:	-20 to + 35°C	
Storing temperature:	-30 to +70°C	
Protection degree:	IP20	
Oversvoltage category:	II.	
Pollution degree:	2	
Operation position:	any	
Installation:	into installation box	
Dimensions:	94 x 94 x 36 mm	
Weight:	155 g	

\* See page 79 for the load chart for each light source.

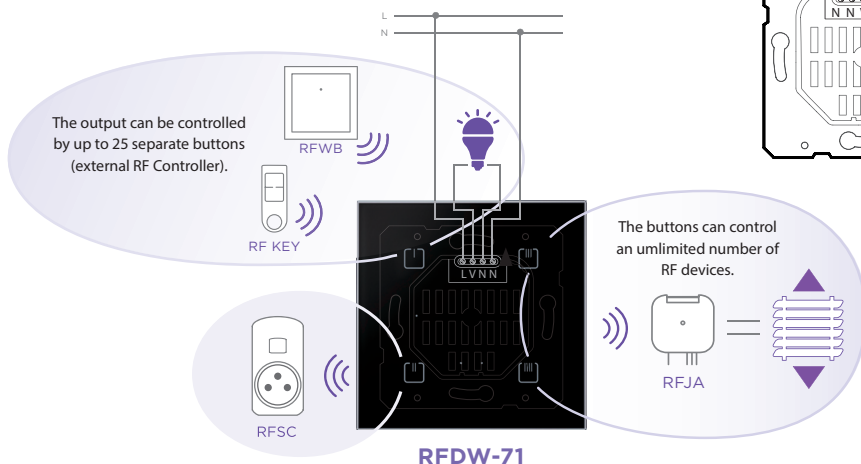

#### Colour variants



RFDW-71/B

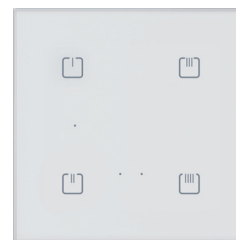

RFDW-71/W

#### Connection

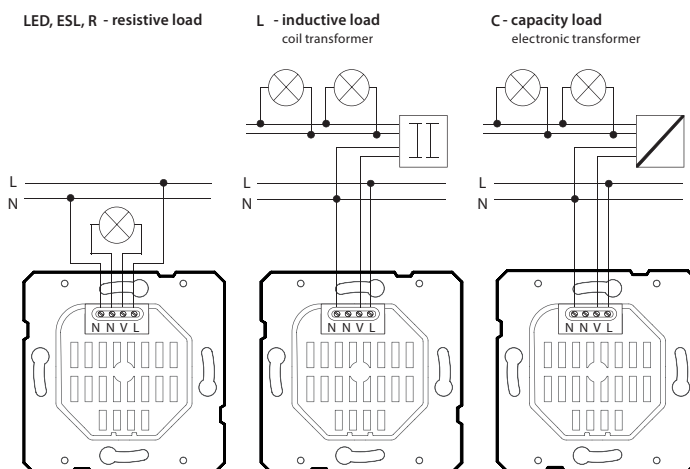

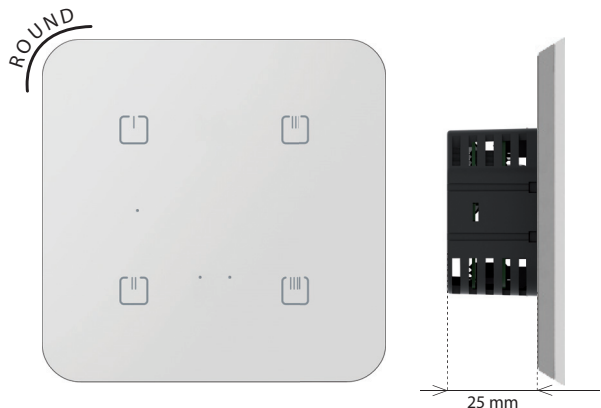

Technical parameters	RFDW-271/230V	RFDW-271/120V
Supply voltage:	230 V AC / 50 Hz	120 V AC / 60 Hz
Apparent power:	1.1 VA	1.1 VA
Dissipated power:	0.8 W	0.8 W
Supply voltage tolerance:	±10 %	
Dimmed load:	R,L,C, LED, ESL	
<b>Input</b>		
Temperature measuring:	YES, built-in temperature sensor	
Scope and accuracy of temp. measurement:	0.. +55°C; 0.3°C from the range	
<b>Output</b>		
Contactless:	2 x MOSFET	
Load capacity:*	max. 160 W	max. 80 W
<b>Control</b>		
Wireless:	up to 25 channels (buttons)	
Communication protocol:	RFIO2	
Frequency:	866–922 MHz (for more information see p. 80)	
Repeater function:	yes	
Manual control:	4 touch keys, button PROG	
Indications touch keys:	red/green LED	
Indications PROG:	colour adjustable prog. mode	
Range:	in open space up to 160 m	
<b>Connection</b>		
Terminals:	0.5 - 1 mm <sup>2</sup>	
<b>Other data</b>		
Operating temperature:	-20 to +35 °C	
Storing temperature:	-30 to +70 °C	
Protection degree:	IP20	
Overvoltage category:	II.	
Pollution degree:	2	
Operation position:	any	
Installation:	into installation box	
Dimensions:	100 x 100 x 36 mm	
Weight:	155 g	

- Glass touch controller designed which serves to regulate light sources:
  - R – classic lamps (resistive load)
  - L – halogen lamps with wound transformer (inductive load)
  - C – halogen lamps with electronic transformer (capacity load)
  - ESL – dimmable energy-efficient fluorescent lamps
  - LED – LED light sources (230 V) equipped with LED.
- 4 channel switch version allows you to control the integrated dimmer as well as other components of the installation.
- They can be combined with detectors, controllers, iNELS RF Control or system components.
- 6 light functions - smooth increase or decrease with time setting 2 s - 30 min. Function description can be found on page 79.
- When switched off, the set level is stored in the memory, and when switched back on, it returns to the most recently set value.
- Thanks to setting the min. brightness by potentiometer, you will eliminate flashing of the LED and ESL light sources.
- The universal dimmer may be controlled by up to 25 channels.
- The programming button on the controller is also used for manual control of the output.
- Memory status can be pre-set in the event of a power failure.
- Range up to 160 m (in open space), if the signal is insufficient between the controller and unit, use the signal repeater RFRP-20 or protocol component RFIO2 that support this feature.
- Communication frequency with bidirectional protocol RFIO2.

Colour variants

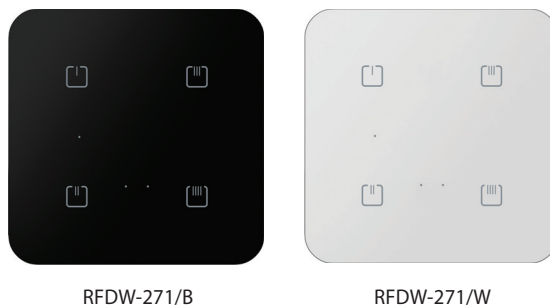

Connection

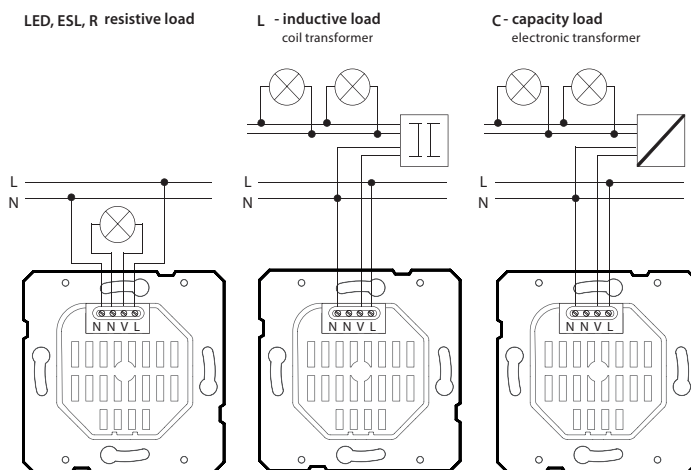

\* See page 79 for the load chart for each light source.

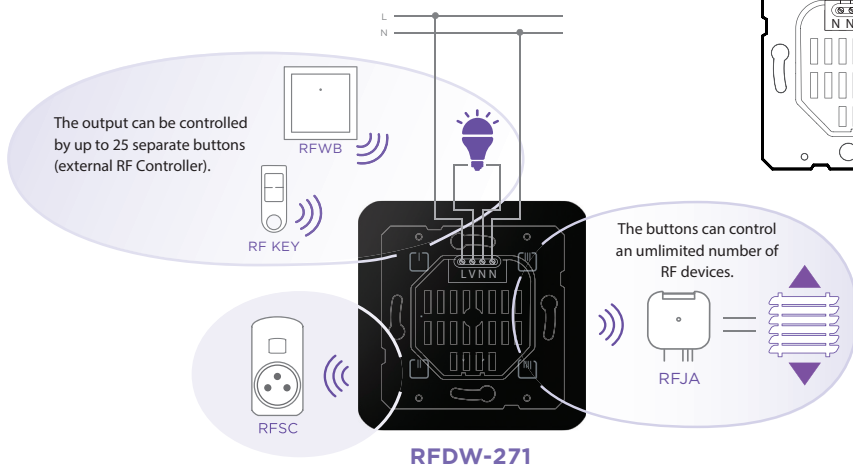



RFDW-271/B | Glass touch controller



Glass touch controller | RFGB-40/W



RFGB-40/W | Glass touch controller



- The key alarm is used to control switches and dimmers (lights, gate, garage door, blinds, etc.).
- When pressing the button, it sends a set signal (ON/OFF, dimming, time switching OFF/ON, blinds up/down).
- Sending a command is indicated by a red LED.
- Four buttons enable control of four units independently.
- Option of setting light scenes, where with a single press, you can control units of iNELS RF Control.
- Battery power supply (3 V CR 2032 battery - included in the supply) with battery life of around 5 years based on frequency of use.
- Range up to 200 m (in open space), if the signal is insufficient between the controller and unit, use the signal repeater RFRP-20 or protocol component RFIO2 that support this feature.
- Designed in black and white with laser printing.

Technical parameters	RF KEY/W	RF KEY/B
Supply voltage:	3 V CR 2032 battery	
Transmission indication:	red LED	
Number of buttons:	4	
Transmitter frequency:	866–922 MHz (for more information see p. 80)	
Signal transmission method:	unidirectionally addressed message	
Range:	in open space up to 200 m	
<b>Other data</b>		
Operating temperature:	-10 to +50 °C	
Operating position:	any	
Colour design:	white	black
Protection:	IP20	
Contamination degree:	2	
Dimensions:	64 x 25 x 10 mm	
Weight:	16 g	
Related standards:	EN 60669, EN 300 220, EN 301 489 R&TTE Directive, Order. No 426/2000 Coll. (Directive 1999/EC)	

Device description

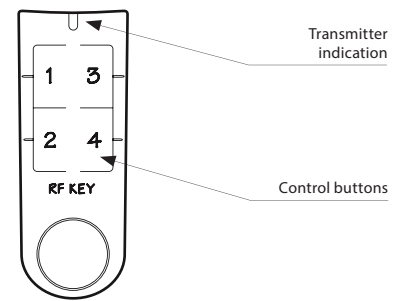



- The Remote RF controller with display is a central controller for switching electrical appliances and equipment, dimming lights, controlling blinds, etc.
- Designed in white and anthracite with colour OLED display.
- 4 directional joystick + 2 buttons for intuitive operation.
- Option of setting light scenes, where with a single press, you can control up to 40 units at once.
- Display of room temperature, battery status, date and time directly on display.
- The Favorites mode lets you preset the most frequently used devices on the home screen.
- Bidirectional communication, transmits and receives commands and displays the status of units.
- Thanks to the function of measuring the signal between the controller and unit, you can use it for testing the range and signal quality.
- Battery power (2x 1.5 V AAA batteries - included in supply) with battery life of around 3 years based on frequency of use and type of batteries.
- Range up to 200 m (in open space), if the signal is insufficient between the controller and unit, use the signal repeater RFRP-20 or protocol component RFIO2 that support this feature.
- Communication frequency with bidirectional protocol RFIO.

Technical parameters	RF Pilot/W	RF Pilot/A
<b>Display</b>		
Type:	colour OLED	
Resolution:	128 x 128 pixels	
Side ratio:	1:1	
Visible surface:	26 x 26 mm	
Backlighting:	self-illuminating text	
Diagonal:	1.5"	
Control:	direction button, control buttons	
<b>Power supply</b>		
Power supply:	2 x 1.5 V AAA batteries/R03	
Battery life:	approx. 3 years, according to the frequency of use and battery type	
<b>Control</b>		
Range:	in open space up to 200 m	
Communication protocol:	RFIO	
Frequency:	866–922 MHz (for more information see p. 80)	
<b>Other data</b>		
Operating temperature:	0 to +55 °C	
Storage temperature:	-20 to +70 °C	
Colour design:	white	anthracite
Protection:	IP20	
Operating position:	any	
Dimensions:	130 x 41 x 18 mm	
Weight:	61 g	
Related standards:	EN 60730-1	

#### Device description

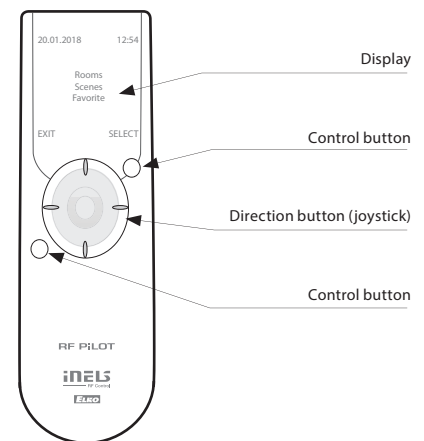

#### RF Pilot

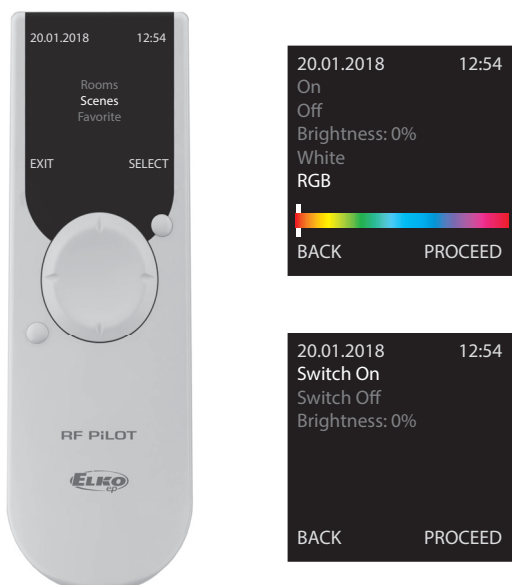

#### Display description

##### Colour LED display

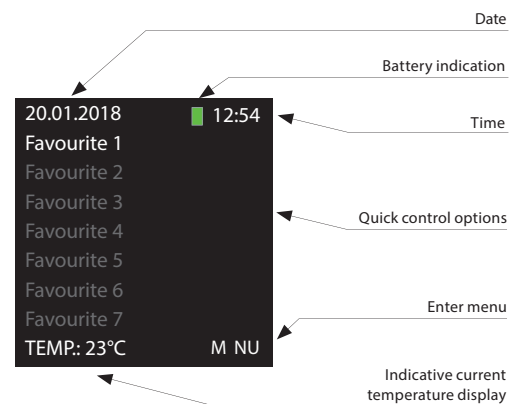

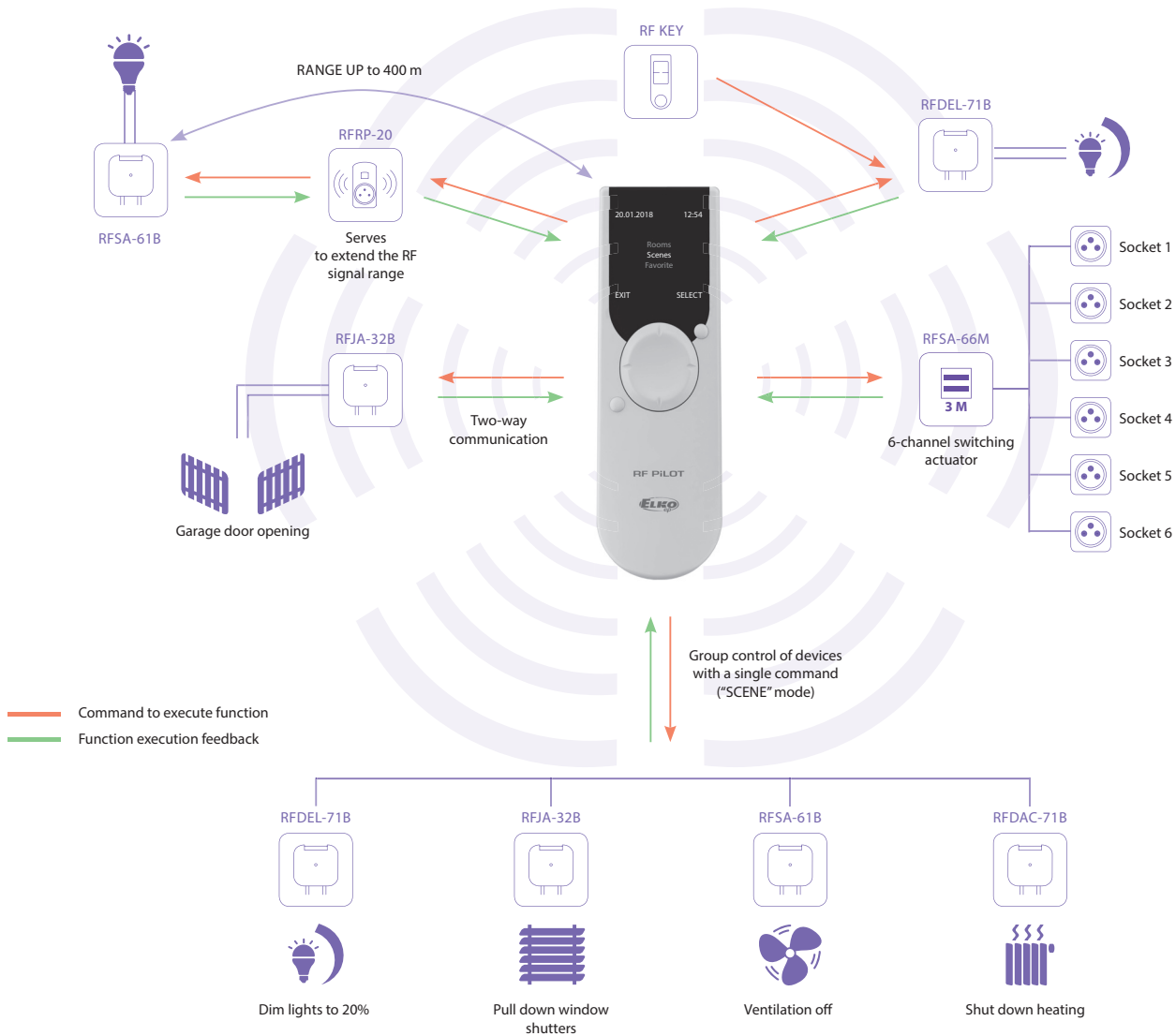

## SCENES

- serves to control actuators as a group with a single touch
- possibility to set up scenes; on activation, for example, window shutters are pulled down and the light will adjust to the required brightness

## WINDOW SHUTTERS

- controlling window shutters, blinds, garage door, etc.
- window shutters are controlled separately or as a group
- the window shutter receivers are powered by either 230 V or 24 V DC (shutters between windows)

## FAVOURITE

- serves to select the most frequently used devices
- on display activation, the "Favourite" menu pops up automatically to provide you with a quick access to controlling devices

## SWITCHING

- this function serves to switch on/off lights, sockets, electrical appliances and devices
- intuitive control thanks to customized name options
- switching actuator function selections: switch on/off, impulse relay, button, delayed ON/OFF (time of delay from 2 seconds to 60 minutes)

## DIMMING

- the regulation of light intensity (light bulbs, LED strips, halogen lights with electrical or coil transformer, fluorescent tubes with dimmable ballast 1-10 V)
- customizable names of individual dimmed circuits (such as "lights" or "living room")
- "sunrise/sunset" imitation - light gradually goes on or off during the preset period between 2 seconds and 30 minutes

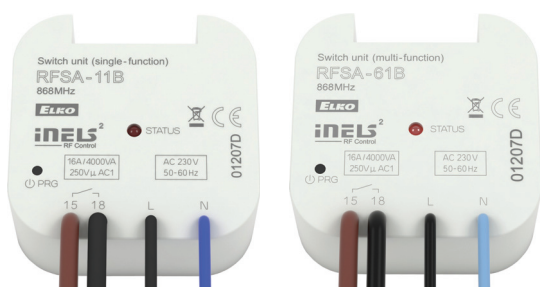

Technical parameters	RFSA-11B/230V	RFSA-11B/120V	RFSA-11B/24V
	RFSA-61B/230V	RFSA-61B/120V	RFSA-61B/24V
Supply voltage:	230 V AC	120 V AC	12-24 V AC / DC
Supply voltage frequency:	50-60 Hz	60 Hz	50-60 Hz
Apparent input:	7 VA / $\cos \varphi = 0.1$	7 VA / $\cos \varphi = 0.1$	-
Dissipated power:	0.7 W	0.7 W	0.7 W
Supply voltage tolerance:	+10 %; -15 %		

#### Output

Number of contacts:	1x switching (AgSnO <sub>2</sub> )
Rated current:	16 A / AC1
Switching power:	4000 VA / AC1, 384 W / DC
Peak current:	30 A / <3 s
Switching voltage:	250 V AC1 / 24 V DC
Max. DC switching power:	500 mW
Mechanical service life:	3x 10 <sup>7</sup>
Electrical service life (AC1):	0.7x 10 <sup>5</sup>

#### Control

Wireless:	up to 25 channels (buttons)
Communication protocol:	RFIO2
Frequency:	866-922 MHz (for more information see p. 80)
Repeater function:	yes
Manual control:	button PROG (ON/OFF)
Range:	in open space up to 200 m

#### Other data

Operating temperature:	-15 to + 50 °C
Operating position:	any
Mounting:	free at lead-in wires
Protection:	IP30
Overvoltage category:	III.
Contamination degree:	2
Terminals (CY wire, cross-section):	2x 0.75 mm <sup>2</sup> , 2x 2.5 mm <sup>2</sup>
Length of terminals:	90 mm
Dimensions:	49 x 49 x 21 mm
Weight:	46 g
Related standards:	EN 60669, EN 300 220, EN 301 489 R&TTE Directive, Order. No 426/2000 Coll. (Directive 1999/EC)

- The switching unit with 1 output channel 16 A is used to control appliances, lights (easy to integrate it to control garage doors or gates).
- They can be combined with detectors, controllers, iNELS RF Control or system components.
- **RFSA-11B:** single-function design - switch on/off.
- **RFSA-61B:** multi-function design – button, impulse relay and time function of delayed ON or OFF with time setting of 2 s - 60 min. Function description can be found on page 78.
- The switching unit may be controlled by up to 25 channels.
- The programming button on the unit is also used for manual control of the output.
- Memory status can be pre-set in the event of a power failure.
- Range up to 200 m (in open space), if the signal is insufficient between the controller and unit, use the signal repeater RFRP-20 or protocol component RFIO2 that support this feature.
- Communication frequency with bidirectional protocol RFIO2.
- The BOX design lets you mount it right in an installation box, a ceiling or controlled appliance cover.

#### Device description

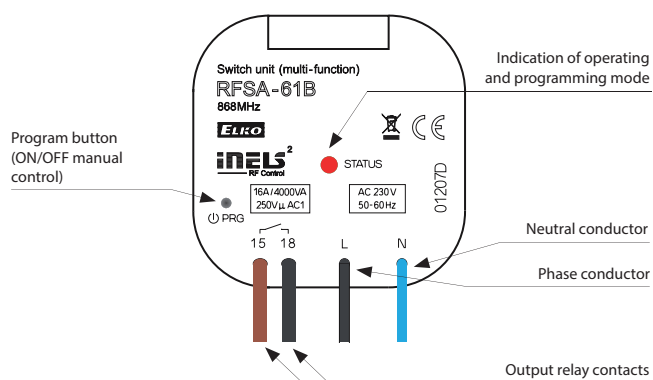

#### Connection

RFSA-11B/230V, RFSA-61B/230V  
RFSA-11B/120V, RFSA-61B/120V

RFSA-61B/24V

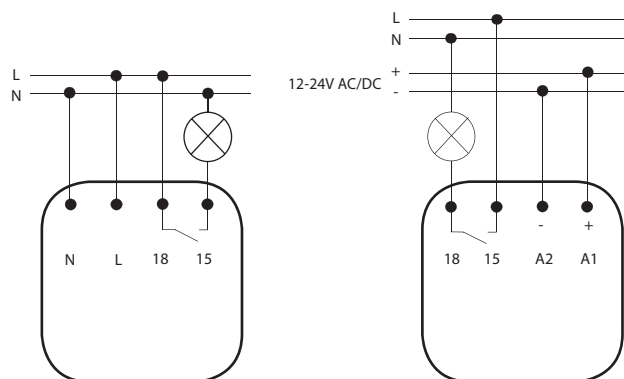



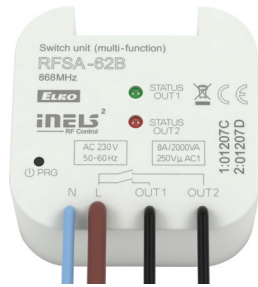

Technical parameters	RFSA-62B/320V	RFSA-62B/120V	RFSA-62B/24V
Supply voltage:	230 V AC	120 V AC	12-24 V AC / DC
Supply voltage frequency:	50-60 Hz	60 Hz	50-60 Hz
Apparent input:	7 VA / $\cos \varphi = 0.1$	7 VA / $\cos \varphi = 0.1$	-
Dissipated power:	0.7 W	0.7 W	0.7 W
Supply voltage tolerance:	+10 %; -15 %		

Output	
Number of contacts:	2 x switching (AgSnO <sub>2</sub> )
Rated current:	8 A / AC1
Switching power:	2000 VA / AC1
Peak current:	10 A / <3 s
Switching voltage:	250 V AC1
Max. DC switching power:	500 mW
Mechanical service life:	1x10 <sup>7</sup>
Electrical service life (AC1):	1x10 <sup>5</sup>

Control	
Wireless:	each of the outputs up to 12 channels (buttons)
Communication protocol:	RFIO2
Frequency:	866–922 MHz (for more information see p. 80)
Repeater function:	yes
Manual control:	button PROG (ON/OFF)
Range:	in open space up to 100 m

Other data	
Operating temperature:	-15 to + 50 °C
Operating position:	any
Mounting:	free at lead-in wires
Protection:	IP30
Overvoltage category:	III.
Contamination degree:	2
Terminals (CY wire, cross-section):	1x 2.5 mm <sup>2</sup> , 3x 0.75 mm <sup>2</sup>   1x2.5, 4x0.75mm <sup>2</sup>
Length of terminals:	90 mm
Dimensions:	49 x 49 x 21 mm
Weight:	46 g
Related standards:	EN 60669, EN 300 220, EN 301 489 R&TTE Directive, Order. No 426/2000 Coll. (Directive 1999/EC)

- The switching unit with 2 output channels 8A used to control two independent appliances.
- They can be combined with detectors, controllers, iNELS RF Control or system components.
- Function: button, impulse relay and time function of delayed start and return with time setting range of 2 s - 60 min. Function description can be found on page 78.
- Each of the channels may be controlled by up to 12 channels.
- The programming button on the unit is also used for manual control of the output.
- Memory status can be pre-set in the event of a power failure.
- Range up to 100 m (in open space), if the signal is insufficient between the controller and unit, use the signal repeater RFRP-20 or protocol component RFIO2 that support this feature.
- Communication frequency with bidirectional protocol RFIO2.
- The BOX design lets you mount it right in an installation box, a ceiling or controlled appliance cover.

Device description

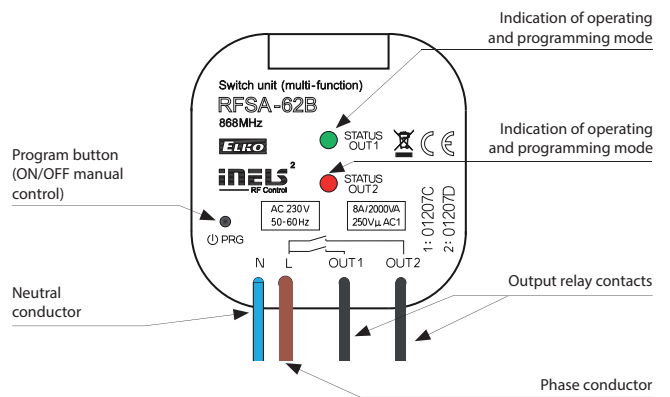

Connection

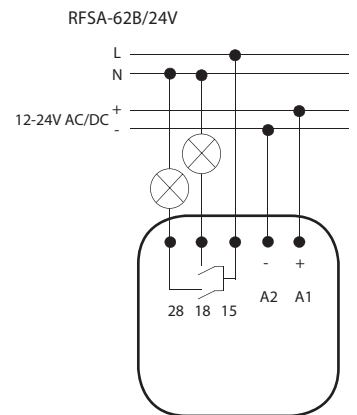
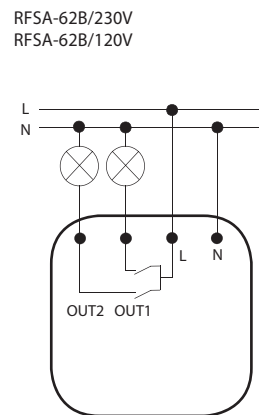

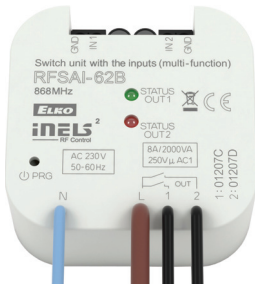

- The switch with 2 output 8 A contacts is used to control 2 independent appliances. Is equipped with inputs for connecting to external buttons for local control.
- They can be combined with detectors, controllers, iNELS RF Control or system components.
- Function: button, impulse relay and time function of delayed start or return with time setting range of 2 s - 60 min. It is possible to assign any function to each output relay. Function description can be found on page 78.
- External button is programmed as a wireless button.
- Input is not galvanic isolated!
- Each output can be controlled by up to 12 channels.
- Memory status can be pre-set in the event of a power failure.
- Range up to 200 m (in open space), if the signal is insufficient between the controller and unit, use the signal repeater RFRP-20 or protocol component RFIO2 that support this feature.
- Communication frequency with bidirectional protocol RFIO2.
- The BOX design lets you mount it right in an installation box, a ceiling or controlled appliance cover.

Technical parameters	RFSAI-62B/230V	RFSAI-62B/120V
Supply voltage:	230 V AC	120 V AC
Supply voltage frequency:	50-60 Hz	60 Hz
Apparent power:	7 VA / $\cos \varphi = 0.1$	
Dissipated power:	0.7 W	
Supply voltage tolerance:	+10 %; -15 %	

Output	
Number of contacts:	2x switching (AgSnO <sub>2</sub> )
Rated current:	8 A / AC1
Switching power:	2000 VA / AC1, 192 W / DC
Peak current:	10 A / <3 s
Switching voltage:	250 V AC1 / 24 V DC
Min. switching power DC:	500 mW
Mechanical service life:	1x10 <sup>7</sup>
Electrical service life (AC1):	1x10 <sup>5</sup>

Controlling	
Wireless:	each of the outputs up to 12 channels (buttons)
Communication protocol:	RFIO2
Frequency:	866–922 MHz (for more information see p. 80)
Repeater function:	yes
Manual control:	button PROG (ON/OFF)
External button:	max. 12 m wire ⚠
Range:	in open space up to 200 m

Other data	
Voltage of open contact:	2.5 V
Resist. of connection for closed contact:	<1 kΩ
Resist. of connection for open contact:	>10 kΩ
Galvanic isolation of input:	no ⚠
Operating temperature:	-15 to + 50 °C
Working position:	any
Mounting:	free at lead-in wires
Protection:	IP30
Overvoltage category:	III.
Contamination degree:	2
Terminals (CY wire, Cross-section):	3x 0.75 mm <sup>2</sup> , 1x 2.5 mm <sup>2</sup>   4x 0.75 mm <sup>2</sup> , 1x 2.5 mm <sup>2</sup>
Terminal length:	90 mm
Dimensions:	49 x 49 x 21 mm
Weight:	46 g
Related standards:	EN 60669, EN 300220, EN 301489 R&TTE Directive, Order. No 426/2000 Coll. (Directive 1999/EC)

Device description

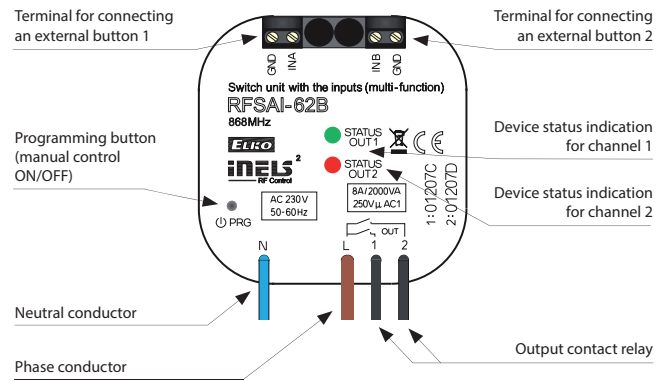

Connection

RFSAI-62B/230V  
RFSAI-62B/120V

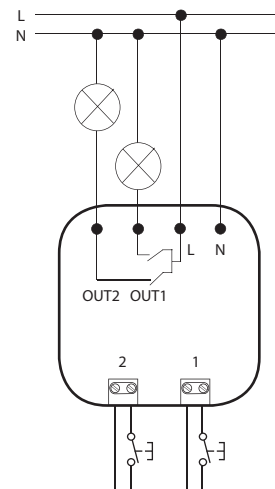

⚠ The external button inputs are at the potential of the main supply voltage.

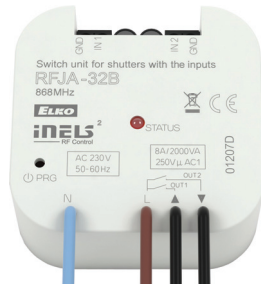

Technical parameters	RFJA-32B/230V	RFJA-32B/120V	RFJA-32B/24V
Supply voltage:	230 V AC	120 V AC	5 - 24V DC
Supply voltage frequency:	50 - 60 Hz	60 Hz	x
Apparent input:	7 VA / $\cos \varphi = 0.1$	7 VA / $\cos \varphi = 0.1$	x
Dissipated power:	0.7 W	0.7 W	x
Power without load:		x	0.5 W
Power under load:		x	20 W
Supply voltage tolerance:	+10 %; -15 %		
<b>Input</b>			
Input:	2x switch or GND		
<b>Output</b>			
Number of contacts:	2 x switching (AgSnO <sub>2</sub> )	contactless	
Rated current:	8 A / AC1	1 A	
Switching power:	2000 VA / AC1	x	
Peak current:	10 A / <3 s	1.5 A / <3 s	
Switching voltage:	250 V AC1	5-24 V DC*	
Mechanical service life:	1x10 <sup>7</sup>	x	
Electrical service life (AC1):	1x10 <sup>5</sup>	x	
<b>Control</b>			
Wireless:	up to 25 channels (buttons)		
Communication protocol:	RFIO2		
Frequency:	866–922 MHz (for more information see p. 80)		
Repeater function:	yes		
Manual control:	PROG (STOP, ▲, STOP, ▼)		
Range:	in open space up to 100 m		
<b>Other data</b>			
Operating temperature:	-15 to + 50 °C		
Operating position:	any		
Mounting:	free at lead-in wires		
Protection:	IP30		
Overvoltage category:	III.		
Contamination degree:	2		
Terminals:	0.5 - 1 mm <sup>2</sup>		
Terminals (CY wire, cross section):	4 x 0.75 mm <sup>2</sup>		
Length of terminals:	90 mm		
Dimensions:	49 x 49 x 21 mm	49 x 49 x 13 mm	
Weight:	46 g	22 g	
Related standards:	EN 60669, EN 300 220, EN 301 489 R&TTE Directive, Order. No 426/2000 Coll. (Directive 1999/EC)		

\* Identical with supply voltage.

- The switching unit for blinds has 2 output channels used to control garage doors, gates, blinds, awnings, etc.
- It can be combined with Control or System units iNELS RF Control.
- **RFJA-32B/230V (120V):** relay contacts 2x 8 A (2x 2000 W), with the possibility of connecting external buttons. The relays block each other (only one direction of movement at a time).
- **RFJA-32B/24VDC:** contactless quiet switching with the ability to connect existing buttons. The drive is controlled by changing the polarity.
- Short presses (<2 s) of the controller enable tilting of lamellas, and a long press (>2 s) enables you to draw the blinds up or down to the end position.
- Each of the units may be controlled by up to 25 channels.
- The programming button on the unit is also used for manual control of the output.
- Range up to 100 m (in open space), if the signal is insufficient between the controller and unit, use the signal repeater RFRP-20 or protocol component RFIO2 that support this feature.
- Communication frequency with bidirectional protocol RFIO2.
- The BOX design lets you mount it right in an installation box, a ceiling or motor drive cover.

**Device description**

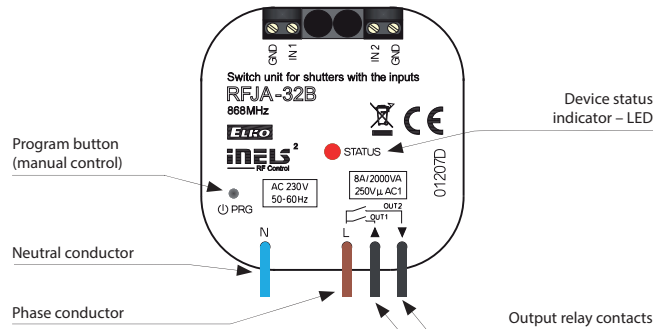

**Function description**

1. Short presses (<2 s) of the control allow the slats to be tilted.
2. When the control button is pressed >2 s shutters move up (▲) or down (▼) until reaching the final position. The travel time of the blinds is set with the programming button.

**Connection**

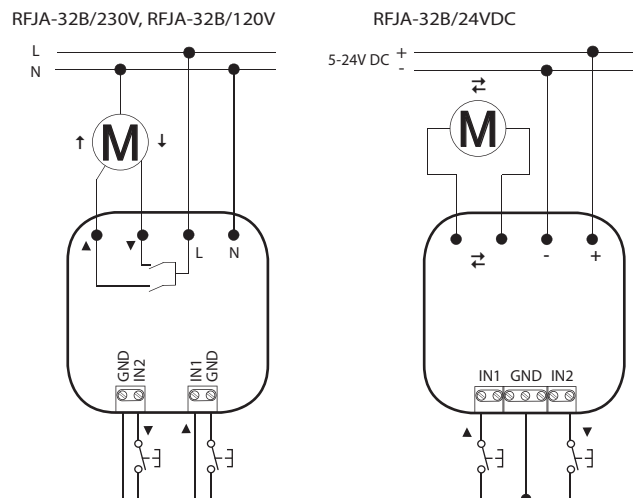



**RFSA-61M**  
1 output

**RFSA-66M**  
6 outputs

Technical parameters	RFSA-61M/230 V	RFSA-66M/230 V	RFSA-66M/24 V
Supply voltage:	110-230 V AC	110-230 V AC	12-24V AC/DC SELV
Supply voltage frequency:	50-60 Hz	50-60 Hz	
Apparent input:	2.7 VA / $\cos \varphi = 0.6$	min. 2 VA / max. 5 VA	-
Dissipated power:	1.62 W	min. 0.5W / max. 2.5W	max. 1.8 W
Supply voltage tolerance:	+10% / -25 %		

#### Output

Number of contacts:	1x changeover (AgSnO <sub>2</sub> )	3x changeover (AgSnO <sub>2</sub> ); 3x switching (AgSnO <sub>2</sub> )
Rated current:	16 A / AC1	8 A / AC1
Switching power:	4000 VA / AC1, 384 W / DC	2000 VA / AC1
Peak current:	30 A / <3 s	10 A / <3 s
Switching voltage:	250 V AC1 / 24 V DC	250 V AC1
Max. DC switching power:	500 mW	500 mW
Mechanical service life:	3x10 <sup>7</sup>	1x10 <sup>7</sup>
Electrical service life (AC1):	0.7x10 <sup>5</sup>	1x10 <sup>5</sup>

#### Control

Wireless:	up to 25 channels (buttons)
Communication protocol:	RFIO2
Frequency:	866-922 MHz (for more information see p. 80)
Repeater function:	yes
Manual control:	PROG (ON/OFF) button
Range:	in open space up to 200 m
IR Antenna:	AN-I included (SMA connector*)

#### Other data

Operating temperature:	-15 °C to + 50 °C
Operating position:	any
Mounting:	DIN rail EN 60715
Protection:	IP20 from the front panel
Overvoltage category:	III.
Contamination degree:	2
Connecting conductor cross-section (mm <sup>2</sup> ):	max. 1x 2.5, max. 2x 1.5 / with a hollow max. 1x 2.5
Dimensions:	90 x 17.6 x 64 mm   90 x 52 x 65 mm
Weight:	74 g   264 g
Related standards:	EN 60669, EN 300 220, EN 301 489 R&TTE Directive, Order. No 426/2000 Coll. (Directive 1999/EC)

- **RFSA-61M:** the switching unit with 1 output channel 16 A is used for controlling appliances, sockets or lights.
  - the one-module design of the unit into a switchboard.
  - the switching unit may be controlled by up to 25 channels.
- **RFSA-66M:** the switching unit with 6 output channels 8 A is used for independent control of up to 6 appliances, sockets or lights.
  - the three-module design of the unit into a switchboard).
  - each of the channels may be controlled by up to 25 channels.
- They can be combined with detectors, controllers, iNELS RF Control or system components.
- Function: button, impulse relay and time function of delayed start or return with time setting range of 2 s - 60 min. Function description can be found on page 78.
- The programming button on the unit is also used for manual control of the output.
- The package includes an internal antenna AN-I, in case of locating the element in a metal switchboard, you can use the external antenna AN-E for better signal reception.
- Memory status can be pre-set in the event of a power failure.
- Range up to 200 m (in open space), if the signal is insufficient between the controller and unit, use the signal repeater RFRP-20 or protocol component RFIO2 that support this feature.
- Communication frequency with bidirectional protocol RFIO2.

#### Device description

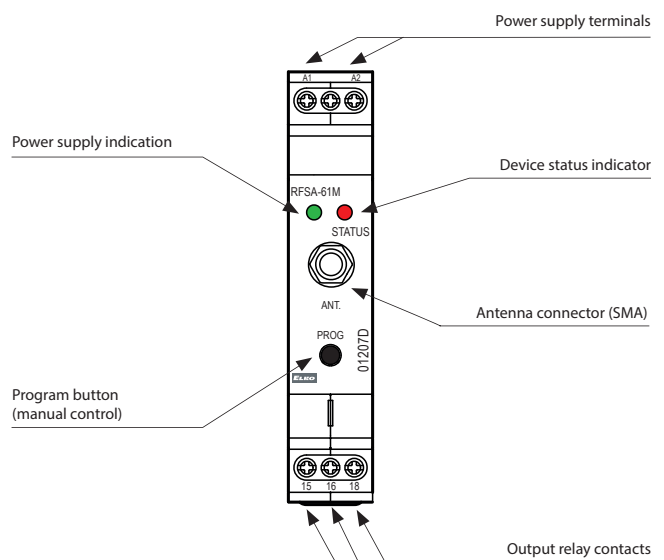

#### Connection

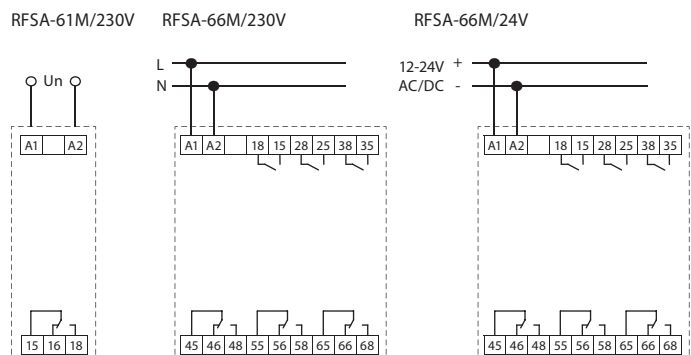

\* Max Tightening Torque for antenna connector is 0.56 Nm.



- The switching unit with 1x 12 A output channel is used for controlling appliances, sockets or lights.
- They can be combined with detectors, controllers, iNELS RF Control or system components.
- Multi-function design – button, impulse relay and time function of delayed ON or OFF with time setting of 2 s - 60 min. Function description can be found on page 78.
- The switching unit may be controlled by up to 25 channels.
- The programming button on the unit is also used for manual control of the output.
- Range up to 200 m (in open space), if the signal is insufficient between the controller and unit, use the signal repeater RFRP20 or protocol component RFIO2 that support this feature.
- Communication frequency with bidirectional protocol RFIO2.
- The increased IP 65 protection is suited to mounting on the wall or in harsh environments such as the cellar, garage or bathrooms.

Technical parameters	RFUS-61/230V	RFUS-61/120V
Supply voltage:	230 V AC	120 V AC
Supply voltage frequency:	50-60 Hz	60 Hz
Apparent power:	5 VA / $\cos \varphi = 0.1$	5 VA / $\cos \varphi = 0.1$
Dissipated power:	0.6 W	0.6 W
Supply voltage tolerance:	+10 %; -15 %	
<b>Output</b>		
Rated current:	1x switching (AgSnO <sub>2</sub> )	
Number of contacts:	12 A / AC1	
Switching power:	3000 VA / AC1, 384 W / DC	
Peak current:	30 A / <3 s	
Switching voltage:	250 V AC1 / 24 V DC	
Min. switching power DC:	500 mW	
Mechanical service life:	3x10 <sup>7</sup>	
Electrical service life (AC1):	0.7x10 <sup>5</sup>	
<b>Control</b>		
Wireless:	up to 25 channels (buttons)	
Communication protocol:	RFIO2	
Frequency:	866–922 MHz (for more information see p. 80)	
Repeater function:	yes	
Manual control:	PROG (ON/OFF) button	
Range:	in open space up to 200 m	
<b>Other data</b>		
Operating temperature:	-15 to + 50 °C	
Operating position:	any	
Mounting:	screws	
Protection:	IP65	
Overvoltage category:	III.	
Contamination degree:	2	
Cross-section of connecting wires (mm <sup>2</sup> ):	max. 1x 2.5, max. 2x 1.5 / with a hollow max. 1x 2.5	
Recommended power cord:	CYKY 3x1.5 (CYKY 4x1.5)	
Dimensions:	136 x 62 x 34 mm	
Weight:	146 g	
Related standards:	EN 60669, EN 300 220, EN 301 489 R&TTE Directive, Order. No 426/2000 Coll. (Directive 1999/EC)	

Device description

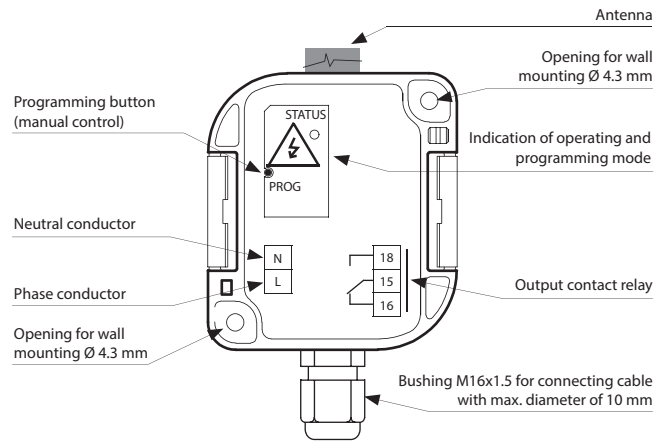

Connection

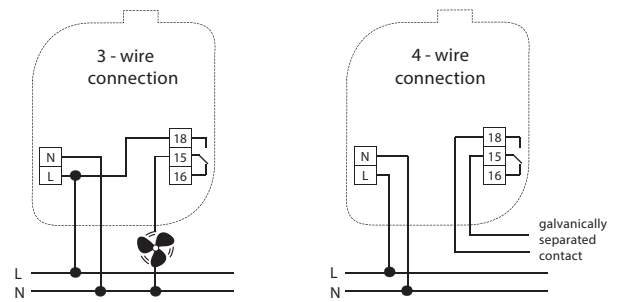



- The switched socket with 16 A output channel is used to control fans, lamps, heaters and appliances, which are connected by a 16 A power cord.
- They can be combined with detectors, controllers, iNELS RF Control or system components.
- Multi-function design – button, impulse relay and time function of delayed ON or OFF with time setting of 2 s - 60 min. Function description can be found on page 78.
- The switched socket may be controlled by up to 32 channels .
- Thanks to the socket design, installation is simple by direct insertion into the existing socket.
- The programming button on the socket is also used for manual control of the output.
- Memory status can be pre-set in the event of a power failure.
- Range up to 200 m (in open space), if the signal is insufficient between the controller and unit, use the signal repeater RFRP-20 or protocol component RFIO2 that support this feature.
- Communication frequency with bidirectional protocol RFIO.

Produced in 5 designs of sockets/plugs:



French

Schuko

British

#### Device description

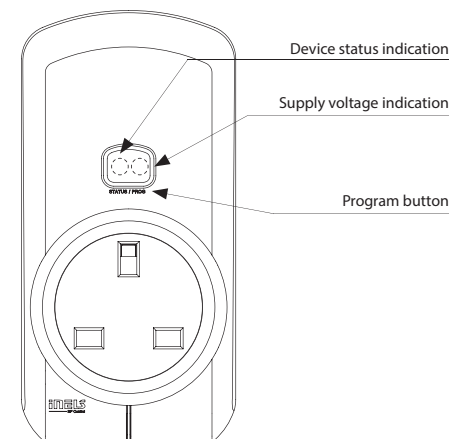

Technical parameters	RFSC-61/230V	RFSC-61/120V
Supply voltage:	230 - 250 V	120 V AC
Supply voltage frequency:	50-60 Hz	60 Hz
Apparent power:	6 VA	
Dissipated power:	0.7 W	
Supply voltage tolerance:	+10 %; -15 %	
<b>Output</b>		
Number of contacts:	1x switching (AgSnO <sub>2</sub> )	
Rated current:	16 A / AC1	
Switching power:	4000 VA / AC1, 384 W / DC	
Peak current:	30 A / <3 s	
Switching voltage:	250 V AC1 / 24 V DC	
Min. switching power DC:	500 mW	
Mechanical service life:	3x10 <sup>7</sup>	
Electrical service life (AC1):	0.7x10 <sup>5</sup>	
<b>Control</b>		
Wireless:	up to 32 channels (buttons)	
Communication protocol:	RFIO	
Frequency:	866–922 MHz (for more information see p. 80)	
Repeater function:	NO	
Manual control:	button PROG (ON/OFF)	
Range:	in open space up to 200 m	
<b>Other data</b>		
Operating temperature:	-15 to + 50 °C	
Working position:	any	
Mounting:	plug into a socket	
Protection:	IP30	
Overvoltage category:	III.	
Contamination degree:	2	
Dimensions:	60 x 120 x 80 mm	
Weight:	195 g	
Related standards:	EN 60669, EN 300 220, EN 301 489 R&TTE Directive, Order. No 426/2000 Coll. (Directive 1999/EC)	

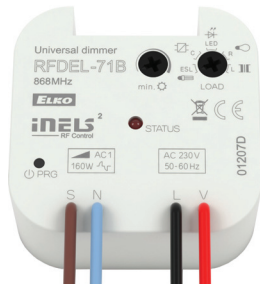

Technical parameters	RFDEL-71B/230V	RFDEL-71B/120V
Supply voltage:	230 V AC	120 V AC
Supply voltage frequency:	50 Hz	60 Hz
Apparent power:	1.1 VA	1.1 VA
Dissipated power:	0.8 W	0.8 W
Supply voltage tolerance:	+10 / -15 %	
Connection:	4-wire, with "NEUTRAL"	
<b>Output</b>		
Dimmed load:	R,L,C, LED, ESL	
Contactless:	2 x MOSFET	
Load capacity:*	max. 160 W	max. 80 W
<b>Control</b>		
Wireless:	up to 25 channels (buttons)	
Communication protocol:	RFIO2	
Frequency:	866–922 MHz (for more information see p. 80)	
Repeater function:	yes	
Range:	in open space up to 160 m	
Manual control:	button PROG (ON/OFF), external button	
Glow lamp connection:	NO	
<b>Other data</b>		
Operating temperature:	-20 to +35°C	
Storage temperature:	-30 to +70°C	
Operating position:	any	
Mounting:	free at lead-in wires	
Protection:	IP30 under normal conditions	
Overvoltage category:	III.	
Contamination degree:	2	
Terminals (CY wire, Cross-section):	4 x 0.75 mm <sup>2</sup>	
Terminal length:	90 mm	
Dimensions:	49 x 49 x 21 mm	
Weight:	40 g	
Related standards:	EN 607 30-1 ED.2	

\* See page 79 for the load chart for each light source.

- The universal built-in dimmer is used to regulate light sources:
  - R – classic lamps (resistive load)
  - L – halogen lamps with wound transformer (inductive load)
  - C – halogen lamps with electronic transformer (capacity load)
  - ESL – dimmable energy-efficient fluorescent lamps
  - LED – LED light sources equipped with LED.
- They can be combined with detectors, controllers, iNELS RF Control or system components.
- 6 light functions - smooth increase or decrease with time setting 2 s - 30 min. Function description can be found on page 79.
- Thanks to setting the min. brightness by potentiometer, you will eliminate flashing of the LED and ESL light sources.
- The universal dimmer may be controlled by up to 25 channels.
- Connection of the existing button on the control input „S“ enables combination of wireless control with classic (wired) control.
- The programming button on the controller is also used for manual control of the output.
- Memory status can be pre-set in the event of a power failure.
- Range up to 160 m (in open space), if the signal is insufficient between the controller and unit, use the signal repeater RFRP-20 or protocol component RFIO2 that support this feature.
- Communication frequency with bidirectional protocol RFIO2.
- The BOX design lets you mount it right in an installation box, a ceiling or light cover.

**Device description**

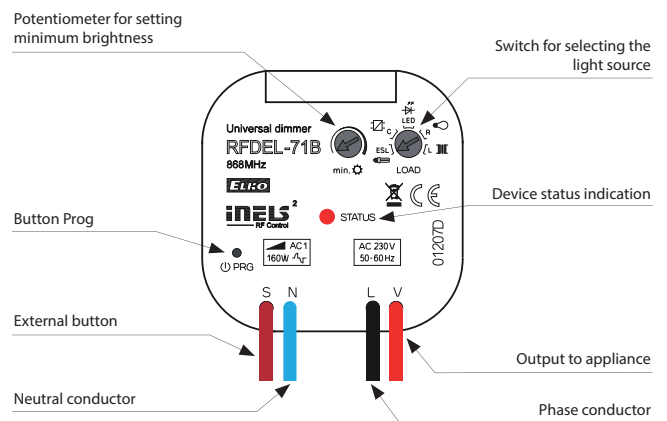

**Connection**

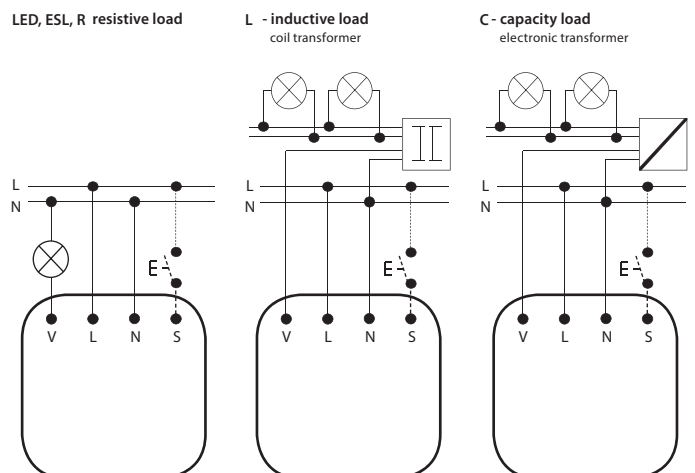

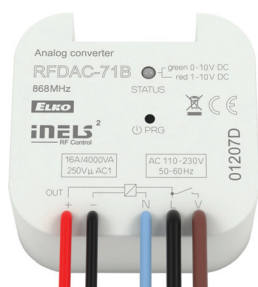

- The device with analog output 0(1) -10 V is used to control devices, luminaires, thermal actuators and thermal heads - which are equipped with such an input.
- They can be combined with detectors, controllers, iNELS RF Control or system components.
- Potential free analog output 0(1) -10 V, contact relay 16 A.
- 6 light functions - smooth increase or decrease with time setting 2 s - 30 min. Function description can be found on page 79.
- The analog controller may be controlled by up to 25 channels.
- The programming button on the controller is also used for manual control of the output.
- Memory status can be pre-set in the event of a power failure.
- Range up to 200 m (in open space), if the signal is insufficient between the controller and unit, use the signal repeater RFRP-20 or protocol component RFIO2 that support this feature.
- Communication frequency with bidirectional protocol RFIO2.
- The BOX design lets you mount it right in an installation box, a ceiling or light cover.

### Technical parameters

### RFDAC-71B

Supply voltage:	110 - 230 V AC
Supply voltage frequency:	50 - 60 Hz
Apparent input:	3 VA
Dissipated power:	1.2 W
Supply voltage tolerance:	+10 / -15 %

### Control

Potential-free analog output / max. current:	0(1)-10 V / 10 mA
Rated current:	1x AgSnO <sub>2</sub> , switches the phase conductor
Switching power:	16 A / AC1
Switching power:	4000 VA / AC1
Switching voltage:	250 V AC1
Mechanical service life:	3x10 <sup>7</sup>
Electrical service life:	0.7x10 <sup>5</sup>
Indication:	red LED/green LED
Output selection:	0(1)-10V / PROG button

### Control

Wireless:	up to 25 channels (buttons)
Communication protocol:	RFIO2
Frequency:	866-922 MHz (for more information see p. 80)
Repeater function:	yes
Manual control:	button PROG (ON/OFF)
Range:	in open space up to 200 m
Minimal control distance:	20 mm

### Other data

Operating temperature:	-15 to + 50 °C
Operating position:	any
Mounting:	plug into a socket
Protection:	IP30
Overvoltage category:	III.
Contamination degree:	2
Terminals (CY wire, cross-section):	3 x 0.75 mm <sup>2</sup> , 2 x 2.5 mm <sup>2</sup>
Length of terminals:	90 mm
Dimensions:	49 x 49 x 21 mm
Weight:	52 g
Related standards:	EN 60669, EN 300 220, EN 301 489 R&TTE Directive, Order. No 426/2000 Coll. (Directive 1999/EC)

### Device description

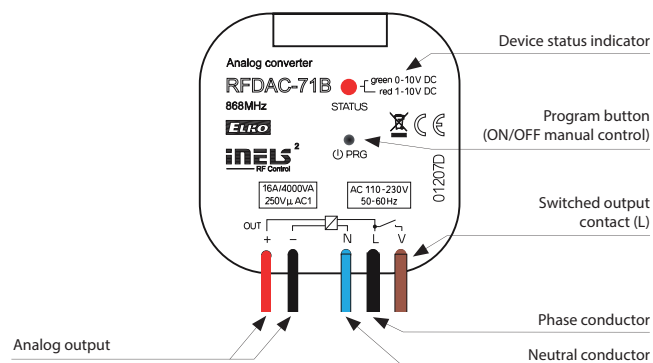

### Connection

Connection example: dimming of fluorescent tubes with dimmable ballast

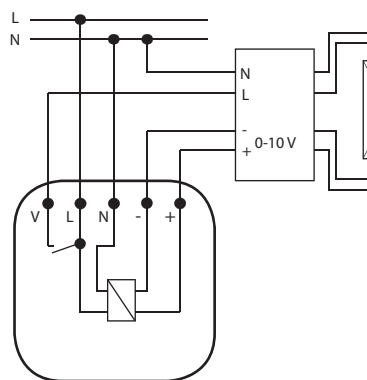

Connection example: with thermo valve

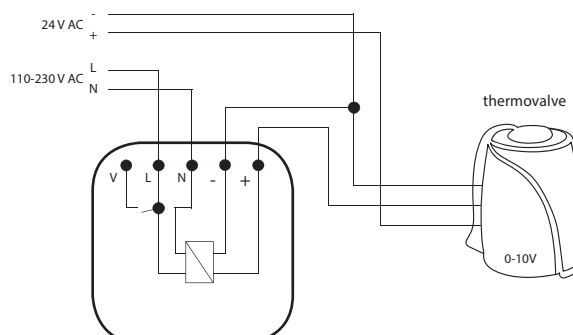





Technical parameters	RFDEL-71M/230V	RFDEL-71M/120V
Supply voltage:	230 V AC	120 V AC
Supply voltage frequency:	50 Hz	60 Hz
Apparent power:	2.5 VA	1.1 VA
Dissipated power:	0.8 W	0.6 W
Supply voltage tolerance:	+10 / -15 %	
<b>Output</b>		
Dimmed load:	R,L,C, LED, ESL	
Contactless:	2 x MOSFET	
Load capacity:*	max. 600 W	max. 300 W*
<b>Control</b>		
Wireless:	up to 32 channels (buttons)	
Communication protocol:	RFIO2	
Frequency:	866–922 MHz (for more information see p. 80)	
Repeater function:	yes	
Range:	in open space up to 160 m	
Manual control:	SW (ON/OFF) button	
External button:	max. 50 m cable	
Glow lamps connection:	NO	
Analog control:	potentiometer or 0 (1) - 10 V	
RF Antenna:	AN-I included (SMA connector**)	
<b>Other data</b>		
Operating temperature:	-20 to + 35 °C	
Storage temperature:	-30 to +70°C	
Operating position:	vertical	
Mounting:	DIN rail EN 60715	
Protection:	IP20 under normal conditions	
Overvoltage category:	II.	
Contamination degree:	2	
Cross-section of connecting wires:	max. 1x 2.5, max. 2x 1.5 / with a hollow max. 1x 2.5	
Dimensions:	90 x 52 x 65 mm	
Weight:	125 g	
Related standards:	EN 607 30-1 ed.2	

\* See page 79 for the load chart for each light source.  
 \*\* Max. Tightening Torque for antenna connector is 0.56 Nm.

- The universal modular dimmer is used to regulate light sources:
  - R – classic lamps (resistive load)
  - L – halogen lamps with wound transformer (inductive load)
  - C – halogen lamps with electronic transformer (capacity load)
  - ESL – dimmable energy-efficient fluorescent lamps
  - LED – LED light sources equipped with LED.
- Control can be performed by:
  - a) detectors, Controllers and System units iNELS RF Control
  - b) by control signal 0(1)-10 V
  - c) potentiometer
  - d) existing button in the installation.
- 6 light functions - smooth increase or decrease with time setting 2 s -30 min. Function description can be found on page 79.
- Thanks to setting the min. brightness by potentiometer, you will eliminate flashing of the LED and ESL light sources.
- The universal dimmer may be controlled by up to 32 channels.
- The programming button on the controller is also used for manual control of the output.
- The package includes an internal antenna AN-I , in case of locating the unit in a metal switchboard, you can use the external antenna AN-E for better signal reception.
- Memory status can be pre-set in the event of a power failure.
- Range up to 160 m (in open space), if the signal is insufficient between the controller and unit, use the signal repeater RFRP-20 or protocol component RFIO2 that support this feature.
- Communication frequency with bidirectional protocol RFIO2.
- The unit’s three-module design with switchboard mounting.

**Device description**

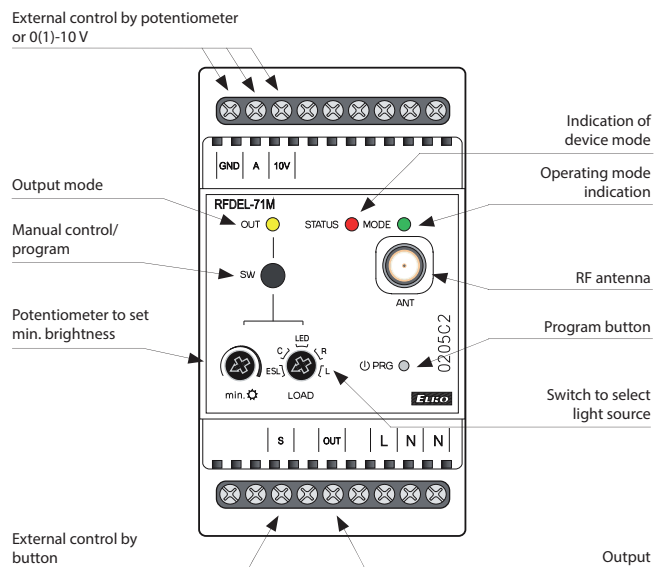

**Connection and external control options**

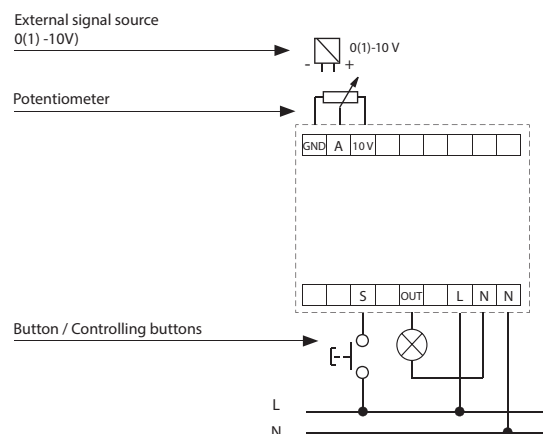



Technical parameters	RFDA-73M/RGB
Supply terminals:	Un+, GND
Supply voltage:	12-24 V DC stabilized
Maximum power without load:	0.8 W
<b>Output</b>	
Dimmed load:	LED strip 12 V, 24 V with common anode RGB LED strips 12 V, 24 V with common anode
Number of channels:	3
Rated current:	3x5 A
Peak current:	3x10 A
Switching voltage:	Un
<b>Control</b>	
Wireless:	up to 32 channels (buttons)
Communication protocol:	RFIO2
Frequency:	866–922 MHz (for more information see p. 80)
Repeater function:	yes
Load capacity of output +10V:	10 mA
Ext. signal:	0-10 V, 1-10 V
Range:	in open space up to 160 m
RF Antenna:	AN-I included (SMA connector*)
<b>Other data</b>	
Operating temperature:	-20 to + 50 °C
Storage temperature:	-30 to + 70 °C
Working position:	any
Mounting:	DIN rail EN 60715
Protection:	IP20 from front panel
Contamination degree:	2
Cross-section of connecting wires (mm <sup>2</sup> ):	max. 1x 2.5, max. 2x 1.5 / with a hollow max. 1x 2.5
Dimensions:	90 x 52 x 65 mm
Weight:	130 g
Related standards:	EN 60730-1; EN 60730-2-11

\* Max Tightening Torque for antenna connector is 0.56 Nm.

- The dimmer for LED strips is used for independent control of 3 single-colour LED strips or one RGB LED strip.
- The expanded selection of control modes enables it to be combined with:
  - a) detectors, controllers and system units iNELS RF Control
  - b) device with output signal 0 (1) -10 V
  - c) potentiometer.
- The unit's three-module design with switchboard mounting enables connection of dimmed load 3x 5 A, which represents:
  - a) single-colour LED strip 7.2 W – 3x 8 m
  - b) RGB LED strip 14.2 W – 10 m.
- 6 light functions - smooth increase or decrease with time setting 2 s - 30 min. Function description can be found on page 79.
- The dimmer may be controlled by up to 32 channels.
- The power supply of the unit is in the range of 12-24 V DC, and is indicated by a green LED.
- The package includes an internal antenna AN-I, in case of locating the unit in a metal switchboard, you can use the external antenna AN-E for better signal reception.
- Memory status can be pre-set in the event of a power failure.
- Range up to 160 m (in open space), if the signal is insufficient between the controller and unit, use the signal repeater RFRP-20 or protocol component RFIO2 that support this feature.
- Communication frequency with bidirectional protocol RFIO2.

### Device description

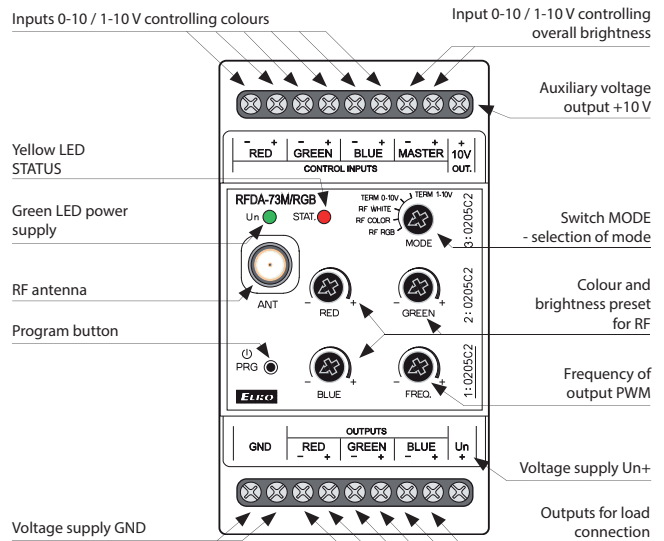

### Output variations and external control options

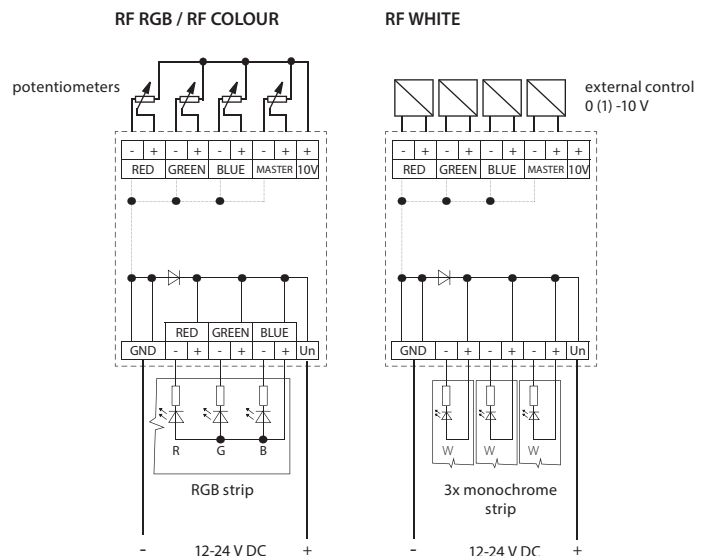

Control modes

RF RGB

Switch settings in MODE:

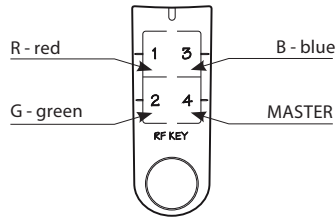
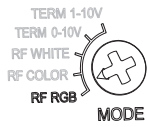

RF RGB mode for controlling RGB LED strips. In the RF RGB programming mode, colours are automatically assigned to individual transmitter buttons.

Note: The mode can be controlled by RF Touch, RF Pilot, RFWB-40/G, RF KEY, RFIM-40B and eLAN-RF-003.

RF Colour

Switch settings in MODE:

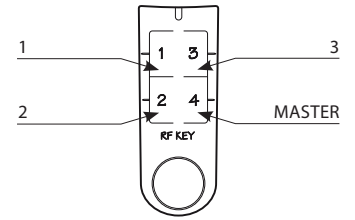
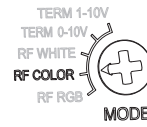

RF COLOUR mode for controlling RGB LED strips, where you can choose the colour for individual transmitter buttons. A long press of the button starts the colour search mode. After releasing the button, the current colour is set for the given button.

Note: The mode can be controlled by RF Touch, RF Pilot, RFWB-40/G, RF KEY, RFIM-40B and eLAN-RF-003.

RF WHITE

Switch settings in MODE:

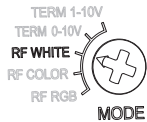

This works in a mode where it acts like three independent dimmers for 12-24 V. Each channel can be programmed independently of one another and has its own address.

Note: The mode can be controlled by RF Touch, RF Pilot, RFWB-20/G, RFWB-40/G, RF KEY, RFIM-20B, RFIM-40B and eLAN-RF-003.

TERM 0-10 V and TERM 1-10 V

Switch settings in MODE:

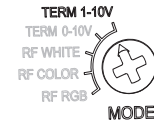
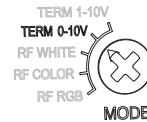

Modes TERM 0-10 V and TERM 1-10 V. Inputs 0-10 V and 1-10 V used to control one RGB LED strip or three independent single-colour LED strips (see modes above) from the iNELS BUS System. For controlling, you can use the application iMM on the TV screen or the application iHC for smartphones and tablets.

Control options

TERM 0(1)-10 V DC - monochrome LED strips

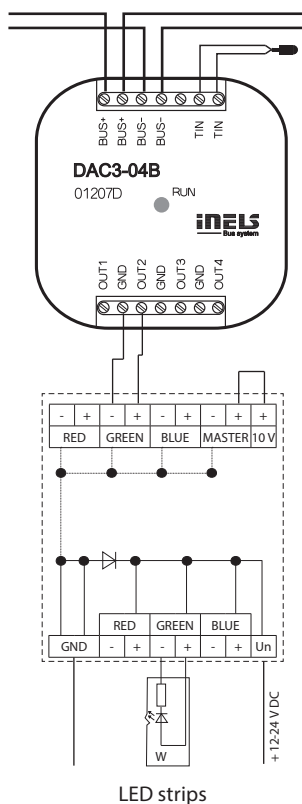

TERM 0(1)-10 V DC - RGB LED strips

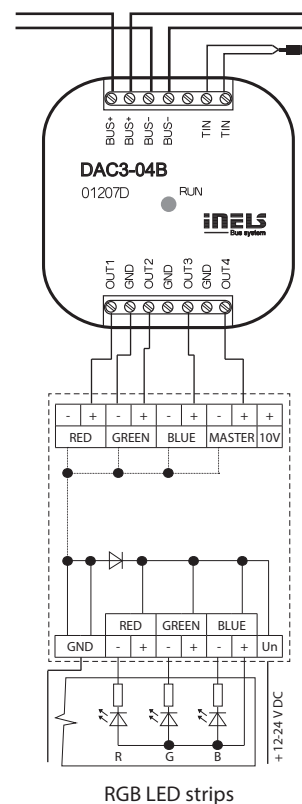



- The dimmed socket is used to control light sources that are connected by power cord - especially lamps:
  - R – classic lamps (resistive load)
  - L – halogen lamps with wound transformer (inductive load)
  - C – halogen lamps with electronic transformer (capacity load)
  - ESL – dimmable energy-efficient fluorescent lamps
  - LED – LED light sources equipped with LED.
- Multi-function 6 light functions - smooth increase or decrease with time setting 2 s - 30 min.
- Thanks to setting the min. brightness by potentiometer, you will eliminate flashing of the LED and ESL light sources.
- The universal dimmer may be controlled by up to 32 channels.
- The programming button on the socket is also used for manual control of the output.
- Memory status can be pre-set in the event of a power failure.
- Range up to 160 m (in open space), if the signal is insufficient between the controller and unit, use the signal repeater RFRP-20 or protocol component RFIO2 that support this feature.
- Communication frequency with bidirectional protocol RFIO.

Produced in 5 designs of sockets/plugs:



French



Schuko

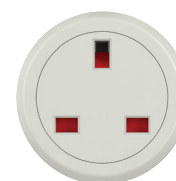

British

Technical parameters	RFDSC-71/230V	RFDSC-71/120V
Supply voltage:	230 - 250 V	120 V AC
Supply voltage frequency:	50-60 Hz	60 Hz
Apparent power:	1.1 VA	
Dissipated power:	0.8 W	
Supply voltage tolerance:	+10/ -15 %	
<b>Output</b>		
Contactless:	2 x MOSFET	
Load capacity*:	max. 300 W	max. 150 W
Dimming load:	R, L, C, LED, ESL	
<b>Control</b>		
Wireless:	up to 32 channels (buttons)	
Communication protocol:	RFIO	
Frequency:	866–922 MHz (for more information see p. 80)	
Repeater function:	yes	
Range:	in open space up to 160 m	
Manual control:	button PROG (ON/OFF)	
<b>Other data</b>		
Operating temperature:	-20 to + 35 °C	
Storage temperature:	-30 to +70°C	
Working position:	any	
Mounting:	plug into a socket	
Protection:	IP30	
Overvoltage category:	III.	
Contamination degree:	2	
Dimensions:	60 x 120 x 80 mm	
Weight:	129 g	
Related standards:	EN 60669, EN 300 220, EN 301 489 R&TTE Directive, Order. No 426/2000 Coll. (Directive 1999/EC)	

\* See page 79 for the load chart for each light source.

#### Device description

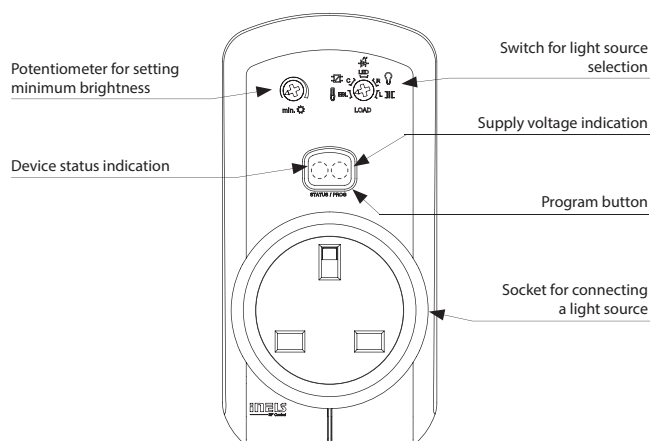

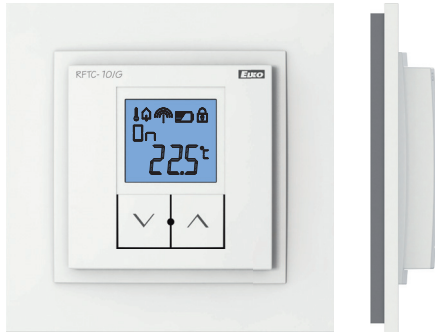

- RFTC-10/G is used for temperature measurement (in the range of 0 to 55 °C) and correction of the pre-set temperature in RF Touch or eLAN-RF system devices in the range of ± 5 °C. The temperature correction is valid until the next program change in the given system device.
- The backlit LCD display displays the current and set temperature, status (ON/OFF), battery status, etc.
- Range up to 100 m (in open space), if the signal is insufficient between the controller and unit, use the signal repeater RFRP-20 or protocol component RFIO2 that support this feature.
- Communication frequency with bidirectional protocol RFIO.
- Colour combination of heating unit in design of frames LOGUS<sup>90</sup> (plastic, glass, wood, metal, stone).

Technical parameters		RFTC-10/G
Supply voltage:		2 x 1.5 V AAA batteries
Battery life:		1 year based on frequency of use
Temperature correction:		2 buttons √ / ▲
Temperature offset:		± 5 °C
Display:		LCD, characters/see Display description
Backlighting:		active 10 s after pressing
Transmission indication/function:		symbols
Temperature measurement:		1x internal sensor
Temp. measurement range and accuracy:		0 to +55 °C; 0.3 °C of the range
Control		
Communication protocol:		RFIO
Frequency:		866–922 MHz (for more information see p. 80)
Repeater function:		NO
Signal transmission method:		bidirectionally addressed message
Range:		in open space up to 100 m
Minimum control distance:		20 mm
Other data		
Max. number of control.		1
RFSA-6x:		x
Operating temperature:		0 to +55 °C
Operating position:		wall-mounted
Mounting:		glue/screws
Protection:		IP30
Contamination degree:		2
Dimensions frame		
- plastic:		85 x 85 x 20 mm
- metal, glass, wood, granite:		94 x 94 x 20 mm
Weight:		66 g (without batteries)
Related standards:		EN 60669, EN 300 220, EN 301 489 R&TTE Directive, Order. No 426/2000 Coll. (Directive 1999/EC)

Device description

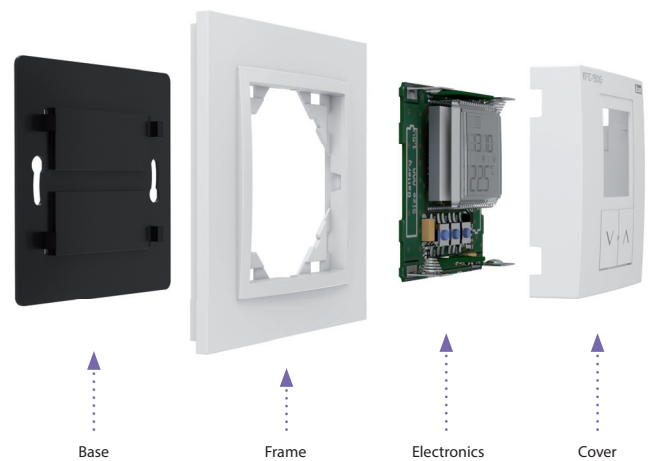

Display description

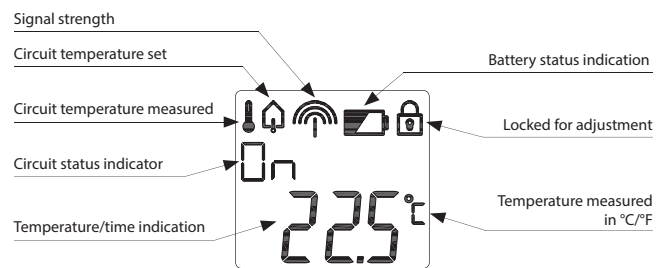

Compatibility				
RF Touch	eLAN-RF	RFSA-6 x	RFSTI-11B	RFATV-1
✓	✓	✓	-	-

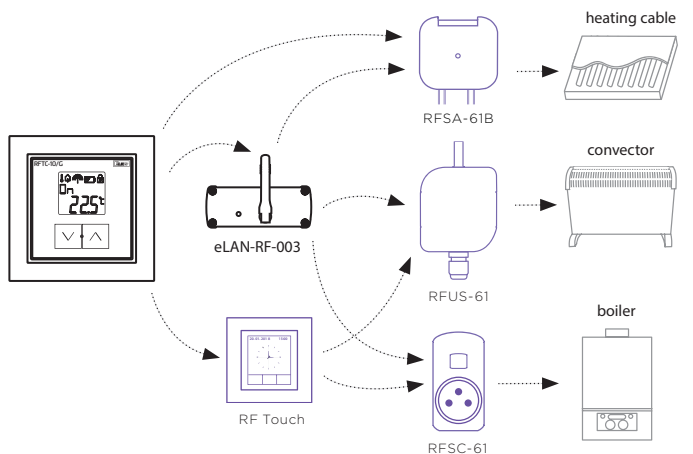



- RFTC-50/G is a separate thermostat that allows wireless control of up to 4 multifunctional switching components, e.g. RFSA-6x, RFUS-61, RFSTI-11B.
- Temperature measurement with built-in sensor in the range of 0.55 °C, temperature setting in the range of 0 to +55 °C in the weekly program.
- The backlit LCD display displays the current and set temperature, status (ON/OFF), battery status, day of the week, current time, etc.
- Battery power (2x 1.5 V AAA batteries - included in supply) with battery life of around 1 year based on frequency of use.
- Range up to 100 m (in open space), if the signal is insufficient between the controller and unit, use the signal repeater RFRP-20 or protocol component RFIO2 that support this feature.
- Communication frequency with bidirectional protocol RFIO.
- Colour combination of temperature unit in design of frames LOGUS<sup>90</sup> (plastic, glass, wood, metal, stone).

### Technical parameters

### RFTC-50/G

Supply voltage:	2x 1.5 V AAA batteries
Battery life:	1 year based on frequency of use according to the number of controlling actuators
Temperature correction:	2 buttons ∇ / ▲
Temperature offset:	± 5 °C
Display:	LCD, characters / see Display description
Backlighting:	active 10 s after pressing
Transmission indication/function:	symbols
Temperature measurement:	1x internal sensor
Temp. measurement range and accuracy:	0 to +55 °C; 0.3 °C of the range

### Control

Communication protocol:	RFIO
Frequency:	866–922 MHz (for more information see p. 80)
Repeater function:	NO
Signal transmission method:	bidirectionally addressed message
Range:	in open space up to 100 m
Minimum control distance:	20 mm

### Other data

Max. number of control.	4
RFSAs:	4
Program:	Weekly
Operating temperature:	0 to +55 °C
Operating position:	on the wall
Mounting:	by gluing/screwing
Protection:	IP30
Contamination degree:	2
Dimensions frame	
- plastic:	85 x 85 x 20 mm
- metal, glass, wood, granite:	94 x 94 x 20 mm
Weight:	66 g (without batteries)
Related standards:	EN 60669, EN 300 220, EN 301 489 directive R&TTE Directive, Order. No 426/2000 Coll. (Directive 1999/EC)

### Compatibility

RF Touch	eLAN-RF	RFSAs	RFSTIs	RFATVs
-	-	✓	✓	-

### Device description

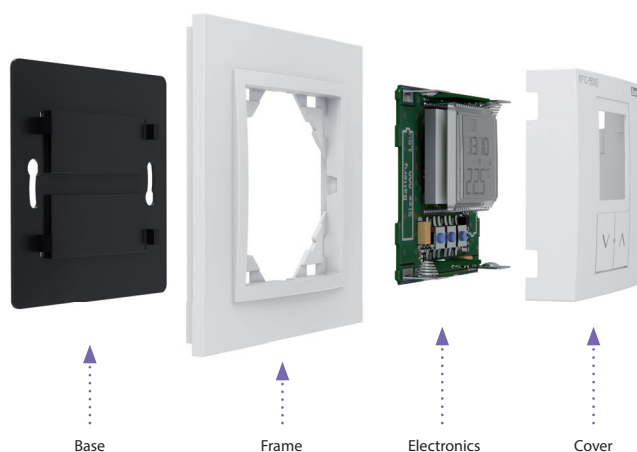

### Display description

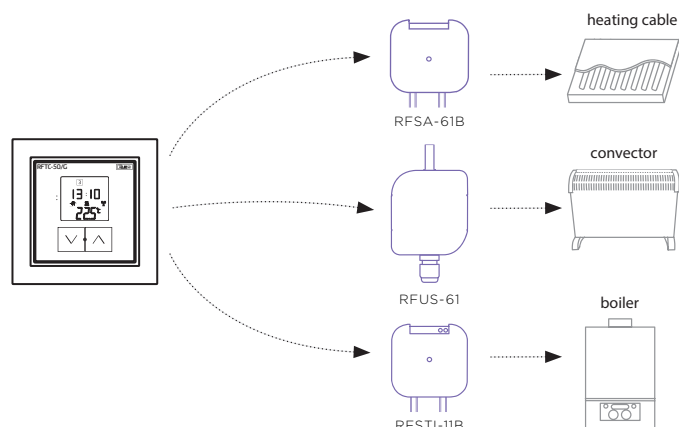
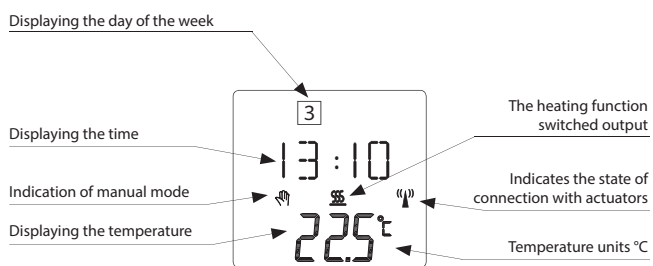



Technical parameters	RFSTI-11B/230V	RFSTI-11B/120V	RFSTI-11B/24V
Supply voltage:	230 V AC	120 V AC	12-24 V AC/DC
Supply voltage frequency:	50-60 Hz	60 Hz	50-60 Hz
Apparent input:	7 VA / $\cos \varphi = 0.1$	7 VA / $\cos \varphi = 0.1$	-
Dissipated power:	0.7 W	0.7 W	0.7 W
Supply voltage tolerance:	+10 %; -15 %		
Temperature measurement input:	1x external TZ/TC temperature sensor input 		
Temp. measurement range and accuracy:	-20 to +50 °C; 0.5 °C of the range		
<b>Output</b>			
Number of contacts:	1x switching (AgSnO <sub>2</sub> )		
Rated current:	16 A / AC1		
Switching power:	4000 VA / AC1, 384 W / DC		
Peak current:	30 A / <3 s		
Switching voltage:	250 V AC1 / 24 V DC		
Max. DC switching power:	500 mW		
Mechanical service life:	3x10 <sup>7</sup>		
Electrical service life (AC1):	0.7x10 <sup>5</sup>		
<b>Control</b>			
Communication protocol:	RFIO2		
Frequency:	866–922 MHz (for more information see p. 80)		
Repeater function:	yes		
Range:	in open space up to 160 m		
<b>Other data</b>			
Operating temperature:	-15 to + 50 °C		
Status indication:	red LED		
Operating position:	any		
Mounting:	free at lead-in wires		
Protection:	IP30		
Overvoltage category:	III.		
Contamination degree:	2		
Outlets (CY wire, cross-section, length):	2 x 0.75 mm <sup>2</sup> , 2 x 2.5 mm <sup>2</sup> , 90 mm		
Dimensions:	49 x 49 x 21 mm		
Weight:	46 g		
Related standards:	EN 60669, EN 300 220, EN 301 489 R&TTE Directive, Order. No 426/2000 Coll. (Directive 1999/EC)		

 Temperature sensor input is at the supply voltage potential.

- The temperature unit measures the temperature by external sensor, and controls the heating circuit (electric underfloor heating, air conditioning, boiler, etc.).
- These can be combined with system units: smart RF box eLAN-RF, wireless controller RFCT-50/G or touch unit RF Touch.
- It measures temperature in a range of -20..50 °C and sends it to the system unit in regular 5 min. intervals. It sends a signal upon sudden temperature change.
- Setting the heat/cool function, hysteresis and offset is performed in the system unit or application.
- It enables connection of the switched load up to 16 A (4 000 W).
- Range up to 160 m (in open space), if the signal is insufficient between the controller and unit, use the signal repeater RFRP-20 or protocol component RFIO2 that support this feature.
- Communication frequency with bidirectional protocol RFIO2.
- The BOX design lets you mount it right in an installation box, a ceiling or controlled appliance cover.
- External sensor TC (-20 to +80 °C) or TZ (-40 to +125 °C) for length of 3 m, 6 m, 12 m. For more information see „Accessories“ on page 41.

### Device description

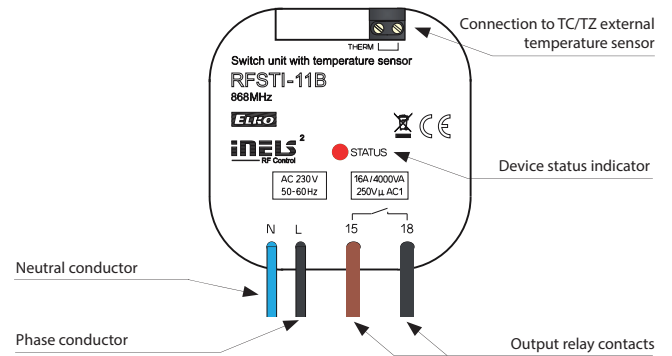

### Connection

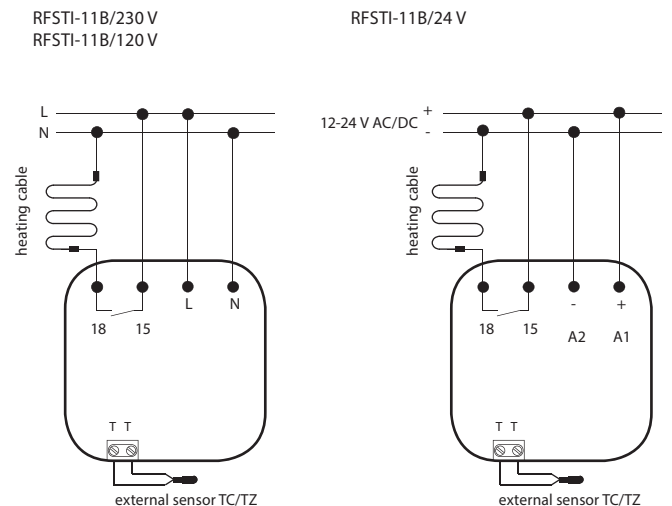

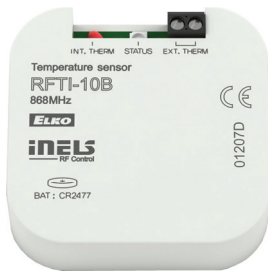

- It measures temperature in a range of -20 to 50 °C with internal or external sensor and sends it to the system unit (eLAN-RF, RF-Touch) in regular 5 min. intervals.
- It sends a signal upon sudden temperature change within 1 min.
- Option of connecting an external sensor to the terminals THERM.
- Battery power (1x 3 V CR 2477 battery - included in supply) with battery life of around 1 year based on frequency of use.
- Range up to 160 m (in open space), if the signal is insufficient between the controller and unit, use the signal repeater RFRP-20 or protocol component RFIO2 that support this feature.
- Communication frequency 868 MHz with bidirectional protocol RFIO.
- External sensor TC (-20 to +80 °C) or TZ (-40 to +125 °C) for length of 3 m, 6 m, 12 m. For more information see „Accessories“ on page 41.

### Technical parameters

### RFTI-10B

Supply voltage:	1x 3 V CR 2477 battery
Battery life:	1 year based on frequency of use
Transmission indication / function:	red LED
Temperature measurement:	1x internal NTC thermistor 1x external TZ/TC temperature sensor input
Temp. measurement range and accuracy:	-20 to +50°C ; 0.5 °C in the range

### Output

Communication protocol:	RFIO
Frequency:	866–922 MHz (for more information see p. 80)
Repeater function:	NO
Signal transmission method:	unidirectionally addressed message
Range:	in open space up to 160 m

### Other data

Operating temperature:	-10 to +50 °C
Operating position:	any
Mounting:	glued/free-standing
Protection:	IP30
Contamination degree:	2
Dimensions:	49 x 49 x 13 mm
Weight:	45 g
Related standards:	EN 60669, EN 300 220, EN 301 489 R&TTE Directive, Order. No 426/2000 Coll. (Directive 1999/EC)

### Device description

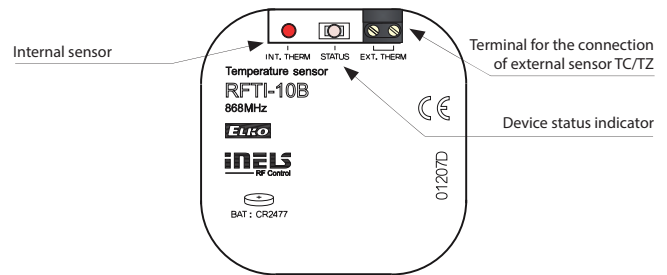

### Sensor location

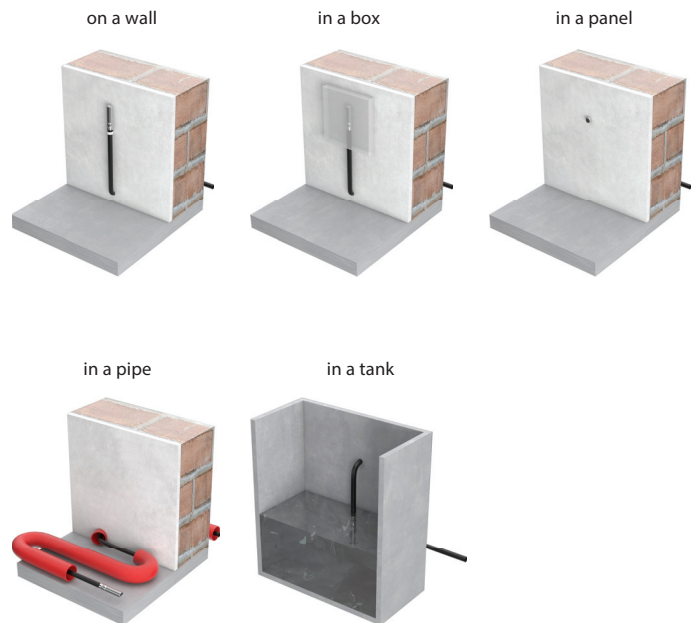



TC, TZ | Temperature sensors



- Thermister temperature sensors are made of Negative Temperature Coefficient (NTC) embedded in a PVC or metal sleeve with a thermally-conductive sealer.
- **Sensor TC**
  - lead-in cable to sensor TC is made of wire CYSY 2D x 0.5 mm/ 0.02".
- **Sensor TZ**
  - cable VO3SS-F 2D x 0.5 mm/0.02" with silicone insulation for use in high temperature applications.
  - silicone insulation for use in high temperature applications.
- Temperature sensors can be connected directly to the terminal block
- cable lengths can not be changed, connected or modified.

Technical parameters	TC	TZ
Range:	-20°C to +80 °C	-40°C to +125°C
Scanning element:	NTC 12K	NTC 12K
Tolerance:	± (0.15°C + 0.002[t])	± (0.3°C + 0.005[t])
In air/ in water:	(τ0.5) ≤ 18 s	(τ65) 62 s / 8 s
In air/ in water:	(τ0.9) ≤ 48 s	(τ95) 216 s / 23 s
Cable material:	PVC unshielded, 2x 0.25 mm <sup>2</sup>	Silicone
Terminal material:	polyamid	nickel plated copper
Protection degree:	IP67	IP67
Electrical strength:	2500 VAC	2500 VAC
Insulation resistance:	> 200 MΩ at 500 VDC	> 200 MΩ at 500 VDC

Types of temperature sensors:		
	TC-0	TZ-0
- length:	100 mm	110 mm
- weight:	5 g	4.5 g
- length:	3 m	3 m
- weight:	70 g	106 g
- length:	6 m	6 m
- weight:	130 g	216 g
- length:	12 m	12 m
- weight:	250 g	418 g

τ65 (95): time, which sensor needs to heat up on 65 (95) % of ambient temperature of environment, in which is located.

Resistive values of sensors in dependance on temperature

Temperature (°C)	Sensor NTC (kΩ)
20	14.7
30	9.8
40	6.6
50	4.6
60	3.2
70	2.3

Tolerance of sensor NTC 12 kΩ is ± 5% by 25 °C / 77°F.

Diagramm of sensor warm up via air

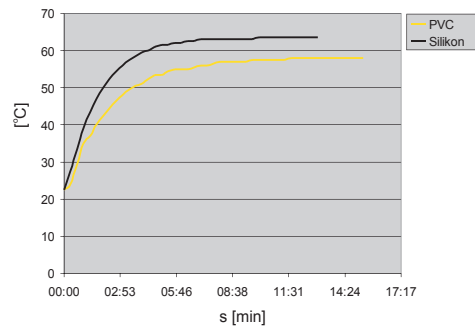

PVC -reaction to water temperature from 22.5°C to 58°C.  
Silicone - reaction to water temperature from 22.5°C to 63.5°C.

Design and dimensions

TC

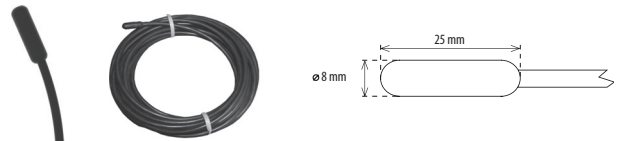

TZ

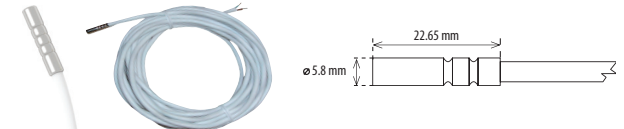



- The wireless thermostat measures room temperature by internal sensor; based on a set program in the system unit, it opens/closes the radiator valve.
- It can be combined with Smart RF box eLAN-RF or touch unit RF Touch.
- It measures temperature in a range of 0 to +32°C and sends it to the system unit in regular 5 min. intervals.
- Monitoring function "Open window", where upon a sudden change in temperature, it shuts the valve for a preset period.
- Setting the hysteresis and offset is performed in the system unit or application.
- Low battery indicator on the display of the system unit or in the application.
- Mounting directly on the valve of the heater (radiator).
- Battery power (2x 1.5 V AA batteries - included in supply) with battery life of around 1 year based on frequency of use.
- Range up to 100 m (in open space), if the signal is insufficient between the controller and unit, use the signal repeater RFRP-20 or protocol component RFIO2 that supports this feature.
- Communication frequency with bidirectional protocol RFIO.
- Package includes: adapters Danfoss RAV, RA, RAVL; 2x 1.5 AA batteries key.

**Technical parameters****RFATV-1**

Supply voltage:	2x 1.5 V AA batteries
Battery life:	1 year based on frequency of use
<b>Control</b>	
Communication protocol:	RFIO
Frequency:	866–922 MHz (for more information see p. 80)
Repeater function:	NO
RF command from the transmitter:	RF Touch, eLAN-RF
Range:	in open space up to 100 m
<b>Other data</b>	
Operating temperature:	0 to +50 °C
Working position:	any
Protection:	IP40
Dimensions:	65 x 65 x 48 mm
Thermostat end:	M 30 x 1.5
Piston stroke:	max. 4 mm
Controlling force:	max. 100 N
Related standards:	EN 60730

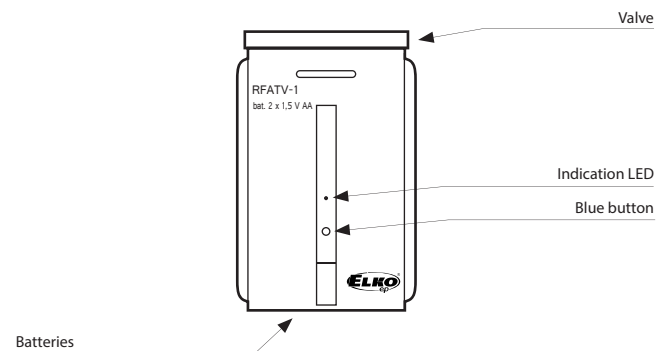
**Device description****Adapters (is included)**

Type of valve	Type of adapter
Danfoss RAV (the valve plunger must be fitted with the enclosed pin):	
Danfoss RA:	
Danfoss RAVL:	



- The thermoregulation drive TELVA is used to control underfloor and radiator hot-water heating.
- It is known for its quiet operation. It has a built-in valve position indicator.
- By mounting using the VA valve adapter, the thermo-regulation drive TELVA is applicable for a wide range of thermostatic valves available on the market.
- Design:
  - without voltage open (NO)
  - without voltage closed (NC)
- Type of use:
 

Underfloor heating - wireless controller RFTC-50/G measures the room temperature, and based on the set program, sends a command to the switching unit RFSA-66M to open/close the thermo-regulation drive TELVA at the distribution.

Technical parameters	TELVA 230V	TELVA 24V
Operating voltage:	230 V, 50 / 60 Hz	24 V, 50 / 60 Hz
Switching current max:	300 mA for max. 2 min	250 mA for max. 2 min
Operating current:	8 mA	75 mA
Closing / opening time:	cca 3 min.	cca 3 min.
Power input:	1.8 W	1.8 W
Protection:	IP54/II	IP54/II
Settings:	4 mm	4 mm
Stopping force:	100 N ±5 %	100 N ±5 %
Cable length:	1 m	1 m
Connecting wire:	2 x 0.75 mm <sup>2</sup>	2 x 0.75 mm <sup>2</sup>
Media temperature:	0 to +100 °C	0 to +100 °C
Colour:	white RAL 9003	white RAL 9003
Dimensions h/w/d:	55+5 x 44 x 61 mm	55+5 x 44 x 61 mm



- **RFIM-20B:** the wireless contact converter changes your existing wired button/switch to a wireless one.
  - two inputs enable control of two units independent.
  - battery power supply (1x 3 V CR 2477 battery - included in the supply) with battery life of around 5 years based on frequency of use.
  - contact can be permanently closed (does not drain on the battery).
- **RFIM-40B:** the wireless contact converter changes your existing wired button to a wireless one.
  - four inputs enable control of four units independently.
  - battery power supply (2x 3 V CR 2032 batteries) with battery life of around 5 years based on frequency of use (included in the supply).
  - button control (input must not be permanently closed)
- It can be used to transmit information on switching on the contact (detector, button, technology, logic output).
- When pressing the button, it sends a set signal (ON/OFF, dimming, time switching OFF/ON, blinds up/down).
- Option of setting light scenes, where with a single press, you can control multiple units of iNELS RF Control.
- Range up to 200 m (in open space), if the signal is insufficient between the controller and unit, use the signal repeater RFRP-20 or protocol component RFIO2 that support this feature.
- Communication frequency with bidirectional protocol RFIO.
- The BOX design lets you mount it right in an installation box under the button or switch.

Technical parameters	RFIM-20B	RFIM-40B
Supply voltage:	1x 3 V CR 2477 battery	2x 3 V CR 2032 batteries
Battery life:	5 years based of frequency use	
Transmission indication / function:	orange LED	red LED
Number of inputs:	2	4
Input switching time:	Permanent input connection (contact)	Short-tem input connection (button)

#### Control

Communication protocol:	RFIO
Frequency:	866–922 MHz (for more information see p. 80)
Repeater function:	NO
Signal transmission method:	unidirectionally addressed message
Range:	in open space up to 200 m

#### Other data

Operating temperature:	-10 to +50 °C	
Operating position:	any	
Terminals (CY wire, cross-section):	4 x 0.75 mm <sup>2</sup>	6 x 0.75 mm <sup>2</sup>
Length of terminals:	90 mm	
Resist.of connection between terminals		
- for switched on button:	< 300 Ω	
- for disconnected contact:	> 10 kΩ	
Mounting:	free at lead-in wires	
Protection:	IP30	
Contamination degree:	2	
Dimensions:	49 x 49 x 13 mm	
Weight:	45 g	50 g
Open contact voltage:	pulse 12 V	3 V
Length of cable to contact:	max. 100 m of parallel lines	max. 5 m
Related standards:	EN 60669, EN 300 220, EN 301 489 R&TTE Directive, Order. No 426/2000 Coll. (Directive 1999/EC)	

#### Device description

RFIM-20B

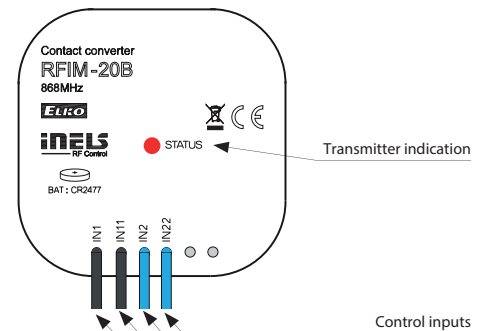

RFIM-40B

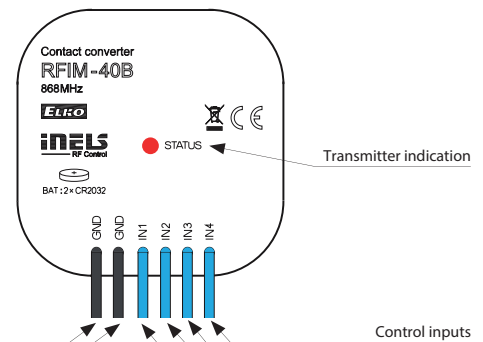

#### Connection

RFIM-20B

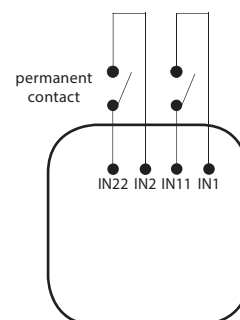

RFIM-40B

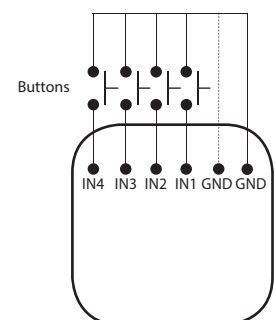



Technical parameters		RFSG-1M
Supply voltage:		110-230 V AC
Supply voltage frequency:		50-60 Hz
Apparent input:		2 VA
Dissipated power:		0.2 W
Supply voltage tolerance:		+10 % / -25 %
Power supply indication:		green LED
Input		
Control voltage:		AC 12-230 V / DC 12-230 V
Control input power:		AC 0.025 VA / DC 0.1 W
Control terminals:		S - S
The length of control impulse:		min. 25ms (max. unlimited)
Transmission indication/function:		red LED
Control		
Communication protocol:		RFIO
Frequency:		866-922 MHz (for more information see p. 80)
Repeater function:		NO
Signal transmission method:		unidirectionally addressed message
Range:		in open space up to 160 m
Minimum control distance:		20 mm
RF antenna:		AN-I included (SMA connector)*
Other data		
Operating temperature:		-15 to +50 °C
Operating position:		any
Mounting:		DIN rail support EN 60715
Protection:		IP20 from the front panel
Overvoltage category:		III.
Contamination degree:		2
Connecting conductor cross-section: (mm <sup>2</sup> ):		max. 1x 2.5, max. 2x 1.5 / with a hollow max. 1x 2.5
Dimensions:		90 x 17.6 x 64 mm
Weight:		62 g
Related standards:		EN 60669, EN 300 220, EN 301 489 R&TTE Directive, Order. No 426/2000 Coll. (Directive 1999/EC)

\* Max Tightening Torque for antenna connector is 0.56 Nm.

- This wireless contact converter is especially appropriate for wireless transmission of information on switching HDO.
- Thanks to the permanent power supply, it can also be used for partial transmission of information for control of an appliance or device.
- After leading in power to the "S" terminals, it periodically transmits the command switch on in an interval of 10 min. When disconnecting the power supply, immediately switch off.
- The button TEST on the controller is used to assign to a switching unit.
- The package includes an internal antenna AN-I, in case of locating the converter in a metal switchboard, you can use the external antenna AN-E for better signal reception.
- Range up to 160 m (in open space), if the signal is insufficient between the controller and unit, use the signal repeater RFRP-20.
- Communication frequency with bidirectional protocol RFIO.
- One-module design of the unit with mounting into switchboard.

Device description

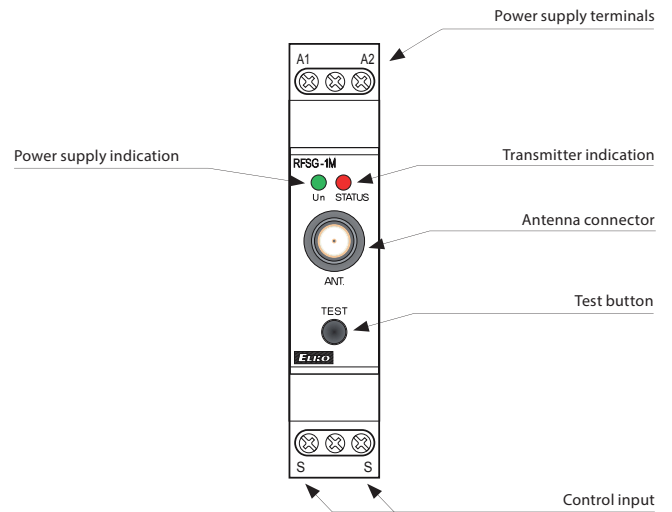

Connection

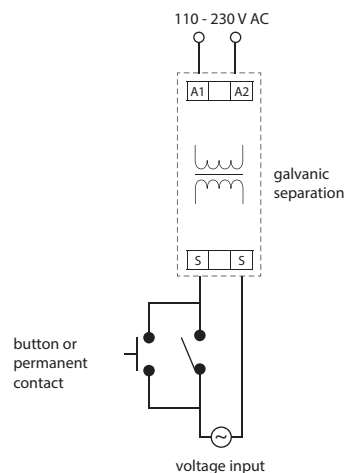



- Monitors areas (e.g. bathrooms, basements, shafts or tanks) to provide flood warning.
- Upon detecting water, the flood detector immediately sends a signal to the switched unit, which further switches on a pump, GSM gate or closes a pipe valve.
- The programming button on the detector is used to:
  - a) setting the function with switching unit
  - b) ascertaining battery status
  - c) ascertaining signal quality between the unit and detector.
- Battery power supply (1x 3 V CR 2477 battery - included in the supply) with battery life of around 1 year based on frequency of use.
- The detector can be placed anywhere thanks to battery power.
- Range up to 160 m (in open space); if the signal is insufficient between the controller and unit, use the signal repeater RFRP-20 or protocol component RFIO2, that support this feature.
- Communication frequency with bidirectional protocol RFIO.
- Option of connecting an external probe FP-1 (not included in supply) - max. wire length 30 m.

### Technical parameters

### RFSF-1B

Supply voltage:	1x 3 V CR 2477 battery
Battery life:	1 year based on frequency use
Indications / transfer function:	red LED
Reset after flooding:	JUMPER - Manual/Automatic
Programming:	with Prog button/based batteries
Measuring input:	terminal 0.5-1mm <sup>2</sup>
Voltage measuring input:	3 V
Resistance measuring input for detecting flooding:	≤20 kΩ
Resistance measuring input for flushing detection:	≥40kΩ
Probe cable length:	max. 30 m

### Control

Communication protocol:	RFIO
Frequency:	866–922 MHz (for more information see p. 80)
Repeater function:	NO
Signal transmission method:	two-way addressed message
Range:	in open space up to 160 m

### Other data

Working temperature:	-10 to +50 °C
Operating position:	any
Mounting:	glue/freely
Protection:	IP30
Degree of pollution:	2
Dimensions:	49 x 49 x 13 mm
Weight:	45 g
Standards:	EN 60730-1, EN 300 220, EN 301 489 directive R&TTE Directive, Order. No 426/2000 Coll. (Directive 1999/EC)

### Device description

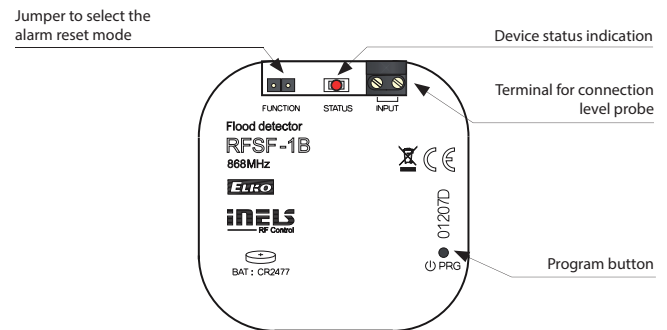

### Location of the detector and probe

In an installation box

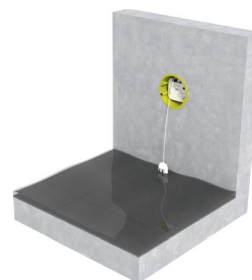

On the wall



Freely



### FP-1 | Liquid probe



### Technical parameters

### FP-1

Working temperature:	-10 to +40 °C
Mounting:	glue/screws
Length of cable:	1 m
Dimensions:	18 x 8 x 26 mm



- The flood detector is used to detect water leakage - the activation occurs the moment the flooding of the contacts located on the underside of the detector occurs.
- Upon detecting water, the flood detector immediately sends a signal to the switched unit, which further switches on a pump, GSM gate or closes a pipe valve.
- Flood detection is signalled by vibration, optical and acoustic signalling.
- Range up to 160 m (in open space); if the signal is insufficient between the controller and unit, use the signal repeater RFRP-20 or protocol component RFIO2 that support this feature.
- Communication frequency with bidirectional protocol RFIO.

**Technical parameters RFSF-100**

**Power supply**

Battery power:	2x 1.5 V AAA batteries
Battery life by frequency 1x 12 hours:	3 years

**Setting**

Alarm Detection:	vibration, optical and audible alarm
Battery status view:	low battery is indicated by flashing 1x in 3 s or display in the system element
Acoustic signal:	greater than 45 dB / 1m

**Detection**

Sensor:	contacts for flooding
Detection principle:	contact between the sensor sensed liquid
Response Time:	2 s after connecting the scanning contacts
Measurement accuracy:	99.8 %
Sensitivity:	in the range 0.03 - 20 kΩ

**Control**

Communication protocol:	RFIO
Frequency:	866-922 MHz (for more information see p. 80)
Repeater function:	NO
Signal transmission method:	two-way addressed message
Range:	in open space up to 160 m

**Other parameters**

Working temperature:	0 to +50°C (Pay attention to the operating temperature of batteries)
Storage temperature:	-20 to +60°C
Operation position:	capture contacts for flooding downwards
Mounting:	loose
Protection degree:	IP62
Dimension:	Ø 89 x 23 mm
Weight:	92 g

**Description**

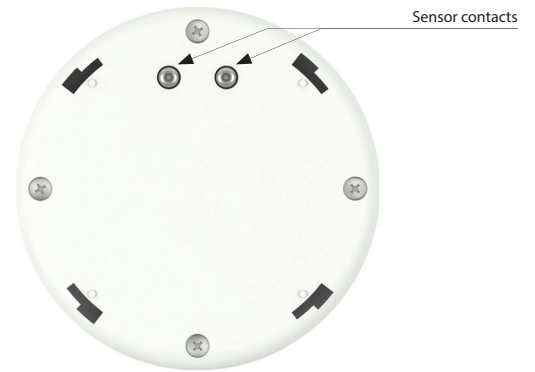

**Function**

When the scanning contact is connected, the detector sends the message and starts alarm.

**Conductivity of liquids**

Liquids suitable for detection		Inadmissible liquids
Type of liquid	Resistivity [Ωcm]*	
Drinking water	5-10 kΩ	Demineralised water
Well water	2-5 kΩ	Deionised water
River water	2-15 kΩ	Bourbon
Rain water	15-25 kΩ	Gasoline
Waste water	0.5-2 kΩ	Oil
Seawater	~0.03 kΩ	Liquid gases
Salt water	~2.2 kΩ	Paraffin
Natural / hard water	~5 kΩ	Ethylene glycol
Chlorinated water	~5 kΩ	Paints
Condensed water	~18 kΩ	High alcohol-content liquids
Milk	~1 kΩ	
Milk serum	~1 kΩ	
Fruit juices	~1 kΩ	
Vegetable Juices	~1 kΩ	
Broths	~1 kΩ	
Wine	~2.2 kΩ	
Beer	~2.2 kΩ	
Coffee	~2.2 kΩ	
Soap toam	~18 kΩ	

\* Resistivity characterizes the local conductivity or resistive properties of materials which conduct electric current.



Technical parameters		RFSOU-1
Power supply:	2 x 1.5 AAA batteries	
Battery Life:	Appr. 2 years, according to the number of controlled units	
Setting the range of light levels		
Function ☾ (twilight switch)		
- Range 1:	1 ... 10 lx	
- Range 2:	10 ... 100 lx	
- Range 3:	100 ... 1.000 lx	
Function ☀ (light switch)		
- Range 1:	100 ... 1 000 lx	
- Range 2:	1 000 ... 10 000 lx	
- Range 3:	10 000 ... 100 000 lx	
Function setting:	rotary switch	
The level of lighting gently:	0.1 ... 1 x range	
Fine adjustment of lighting levels:	potentiometer	
The time delay t:	0 / 1 min. / 2 min.	
Setting the delay time t:	rotary switch	
Control		
Communication protocol:	RFIO	
Frequency:	866–922 MHz (for more information see p. 80)	
Repeater function:	NO	
Range:	in open space up to 160 m	
Other data		
Working temperature:	-20 to +50°C	
Storage temperature:	-30 to +70°C	
Operating position:	sensor side down	
Protection:	IP65	
Degree of pollution:	2	
Dimension:	72 x 62 x 34 mm	
Weight:	104 g	
Standards:	EN 60730-1, EN 300 220, EN 301 489 R&TTE Directive, Order. No 426/2000 Coll. (Directive 1999/EC)	

- The twilight switch measures the light intensity and based on a set value, it sends the command to switch on the lights or pull the blinds up or down.
- It can be combined with multifunctional switching units and blind switches.
- Integrated sensor for measuring illumination, settable in 3 ranges 1-100,000 lx.
- Selection of function:
  - a) twilight switch – automatically switches on upon a decrease in ambient light intensity, switches off upon an increase (appropriate for garden lights, advertisements, public lighting, etc.).
  - b) light switch – automatically switches on upon an increase in ambient light intensity, switches off upon a decrease (appropriate for offices, restaurants, rooms, etc.).
- Settable delay up to 2 minutes to eliminate unwanted switching caused by surrounding influences.
- The twilight switch may control up to 32 units in the installation.
- The programming button on the regulator is used for:
  - a) setting a function with a switching or blind unit
  - b) ascertaining battery status
  - c) ascertaining signal quality between the unit and dimmer.
- Battery power (2x 1.5 V AAA batteries - included in supply) with battery life of around 2 years based on the number of controlled units.
- Range up to 160 m (in open space), if the signal is insufficient between the controller and unit, use the signal repeater RFRP-20 or protocol component RFIO2 that support this feature.
- Communication frequency with bidirectional protocol RFIO.
- The increased IP65 protection is suited to mounting on the wall or into the rural environment.

#### Device description

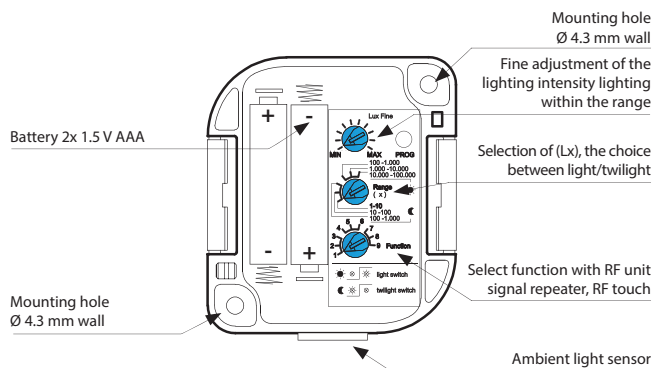





Technical parameters		RFMD-100
Power supply:	2x 1.5 V AA batteries	
Battery life:	up to 1 year, according to the number of activations	
Drained battery indicator:	yes	
Control		
Communication protocol:	RFIO	
Frequency:	866–922 MHz (for more information see p. 80)	
Repeater function:	NO	
Detection angle:	105°	
Detection distance:	max. 12 m	
Recommended working height:	max. 2.4 m	
Other data		
Working temperature:	-10 to +50°C	
Protection:	IP20	
Colour:	white	
Dimension:	46 x 105 x 43 mm	
Weight:	57 g	

- The motion detector PIR is used to detect persons moving inside the building interior.
- Use:
  - in combination with a switching unit for automatic control of lighting or triggering an alarm.
  - by means of the Smart RF box, detection can be displayed on your smart phone in the form of a notification; alarms are stored in the history, which is visualized in the application iHC.
- Sensitivity settings of the PIR detector for eliminating unwanted triggering.
- Integrated lighting sensor, thanks to which you can set the detector's reaction time.
- Option of activation/deactivation of the LED indicator on the detector cover.
- Anti-tamper function: an alarm is triggered if there is an unauthorized interference to detector.
- Power supply: 2x 1.5 V AA batteries, the battery life is around 1 year.
- "Low Battery" Alerts by double LED flashing or on iHC App.
- The detectors are compatible with switching components marked with the RFIO2 communication protocol and the eLAN-RF system components.
- Communication frequency with bidirectional protocol RFIO.

Detection field

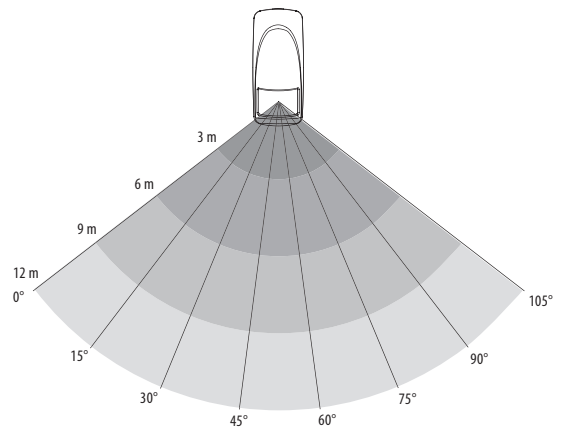



- The smoke detector is used for timely warning against a fire started in residential and commercial buildings.
- Use:
  - autonomous fire detector with internal siren
  - in combination with a switching unit for external signaling (light, appliance, siren)
  - by means of the Smart RF box, detection can be displayed on your smart phone, in the form of a notification; alarms are stored in the history, which is visualized in the application iHC.
- Anti-tamper function: an alarm is triggered if there is an unauthorized interference to detector.
- Power supply: 4x 1.5 V AA batteries, the battery life is around 1 year, thanks to the ability to turn off the LED indicator it is possible to extend up to 3 years.
- "Low Battery" Alerts by double LED flashing or on iHC App.
- The detectors are compatible with switching components marked with the RFIO2 communication protocol and the eLAN-RF system components.
- Communication frequency with bidirectional protocol RFIO.

Technical parameters	RFSD-100	RFSD-101
Power supply:	4x 1.5 V AA batteries	
Low battery indication:	ano	
<b>Detectors</b>		
Smoke detection:	built-in sensor	
Detection:	smoke from burning	
Detection principle:	optical-smoke scanning technology	
Response time:	a few seconds after contact with the smoke	
Temperature measuring:	x	built-in sensor
Range:	x	-25 to 70 °C
Accuracy:	x	± 3 °C
Humidity measuring	x	built-in sensor
Sensitivity:	x	0 to 90 % RH
Accuracy:	x	± 4 %
Light intensity measurement:	x	built-in sensor
Range:	x	0.045 - 188 000 Lx
<b>Setting</b>		
Button SET:	test/setting/signalling	
DIP switch:	position 1 Turn off LED signalling	
<b>Control</b>		
Detection area:	max. 40 m <sup>3</sup>	
Recommended installation height:	max. 4 m	
Acoustic signal:	greater than 85 dB at 3 metres	
Test button:	yes	
Communication protocol:	RFIO	
Frequency:	866–922 MHz (for more information see p. 80)	
Repeater function:	NO	
<b>Other data</b>		
Humidity:	up to 92% relative humidity(RH) / 10% až 85% RH, no condensation or frost	
Working temperature:	0 to +40°C (Pay attention to the operating )	
Storage temperature:	-30 to +70°C	
Operation position:	horizontal (ceiling)/vertical (wall)	
Mounting:	screws	
Protection degree:	IP20	
Colour:	white	
Dimension:	Ø 120 x 36 mm	
Weight:	176 g (without battery)	

#### Funkce

An internal, battery-powered smoke detector combines the timely detection of smouldering and open fires from which smoke escapes. It is equipped with an optical smoke detector for smoke detection. An example of a smouldering fire is a burning cigarette on a couch or bedding, which is a common cause of fires.

#### Indication and detector states:

After inserting the batteries, the detector sends an introductory message containing the measured temperature, humidity, light intensity, optical-smoke sensor status, and firmware version of the device.

- The detector scans for smoke every 10 seconds, the green LED blinks at the same time (the LED signalling can be switched off by the DIP switch). Every 10 minutes the detector senses temperature, humidity and light intensity. Displays the measured data report at six hourly intervals. In the case of smoke detection or rapid temperature change it is displayed immediately.
- Alarm - the sensor detects smoke, the red LED blinks within 1 second, the detector emits a loud, intermittent „beep“. Terminate the alarm by scattering the smoke. The audible alarm can be switched off by the test button, in the case of positive smoke detection; the audible alarm is restored after 5 minutes.
- Dead battery:
  - sending a message to the server
  - every 50 s 3 times the red LED lights up on the detector.
  - every 7 min the detector beeps.
- Removed from base:
  - sending a message to the server
  - every 3 seconds the red LED lights up on the detector.

Device decay

Description

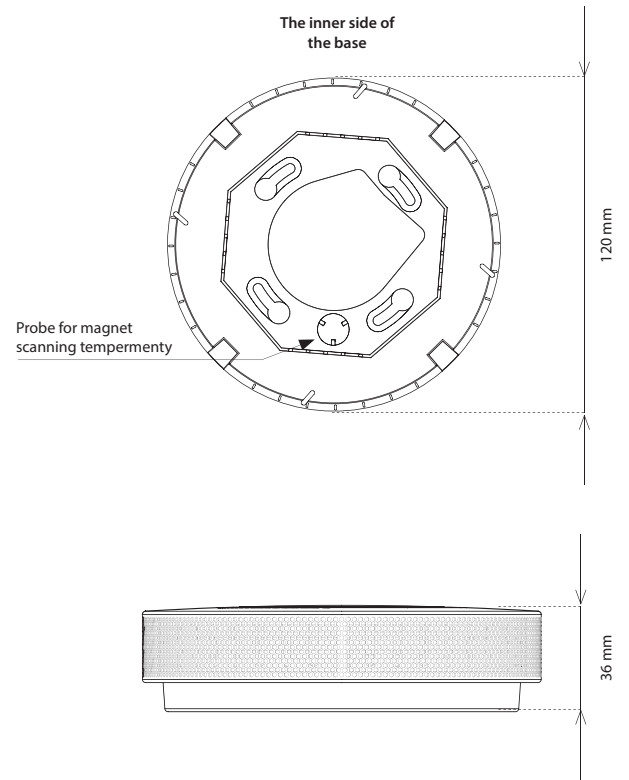
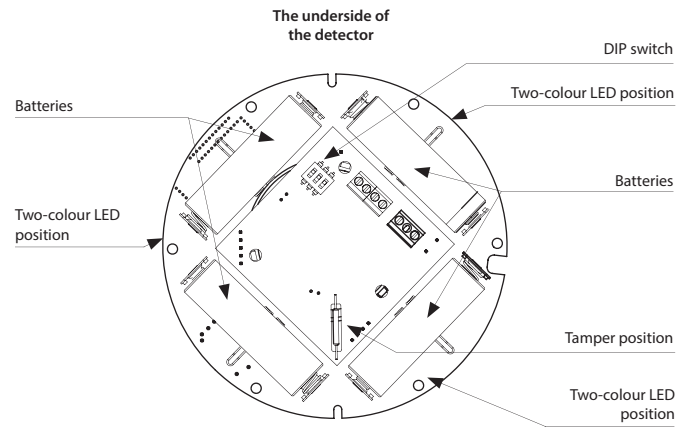
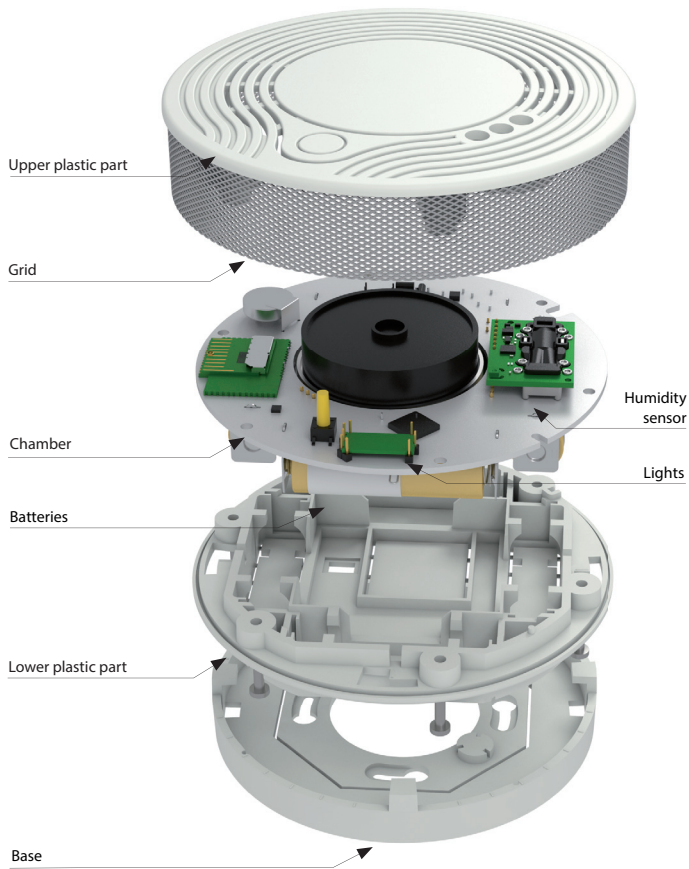

Assembly

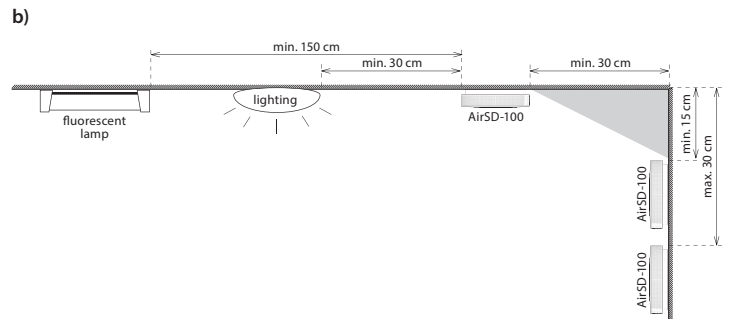
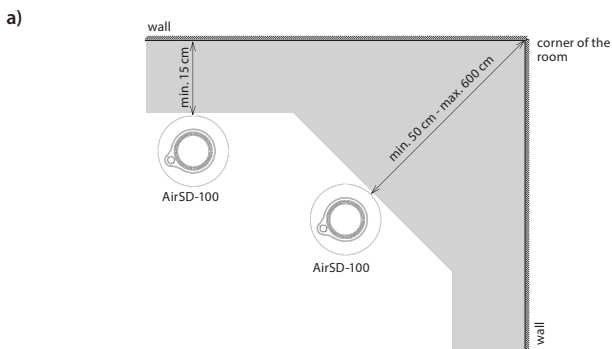



- The Window/Door detector is used to detect opening where activation occurs when the magnet and the sensor become separated.
- Use:
  - in combination with the switching unit for automatic light control (cellar, garage, etc.), or switching on a GSM gate
  - by means of the Smart RF box, detection can be displayed on your smart phone in the form of a notification; alarms are stored in the history, which is visualized in the application iHC.
- Anti-tamper function: an alarm is triggered if there is an unauthorized interference to detector.
- Power supply: 1x 3 V CR 2032 battery, the battery life is around 1 year, thanks to the ability to turn off the LED indicator it is possible to extend up to 3 years.
- "Low Battery" Alerts on Your iHC App.
- The detectors are compatible with switching components marked with the RFIO2 communication protocol and the eLAN-RF system components.
- Communication frequency with bidirectional protocol RFIO.

Technical parameters	RFWD-100
Power supply:	1x 3 V CR 2032 battery
Drained battery indicator:	yes
<b>Control</b>	
Communication protocol:	RFIO
Frequency:	866–922 MHz (for more information see p. 80)
Repeater function:	NO
<b>Other data</b>	
Working temperature:	-10 to +50°C
Protection:	IP20
Colour:	white
Dimension:	25 x 75 x 16 mm
Magnet dimension:	15 x 75 x 14 mm



Window/Door detector | RFWD-100



Smoke detector | RFSD-100



Flood detector | RFSF-100



RF Touch- B



RF Touch- W

- The Wireless touch unit RF Touch is a central controller for heating, switching electrical appliances and equipment, dimming lights, controlling blinds, etc.
- It transmits and receives commands from units and processes set programs for automatic control.
- Thanks to bidirectional communication, it visualizes the current status of individual units.
- Automatic control based on weekly program.
- It is possible to combine up to 40 units of iNELS RF Control + 30 Oasis detectors (you can gradually expand the installation from 1 unit).
- Power to the touch unit is in the range 100-230 V AC, (RF Touch/W also supplied via adapter 12 V DC included in the supply).
- Range up to 100 m (in open space), if the signal is insufficient between the RF Touch and unit, use the signal repeater RFRP-20 or protocol component RFIO2 that support this feature.
- Communication frequency with bidirectional protocol RFIO.

Technical parameters	RF Touch-B	RF Touch-W
<b>Display</b>		
Type:	colour TFT LCD	
Resolution:	320 x 240 pixels / 262,144 colours	
Side proportion:	3:4	
Visible surface:	52.5 x 70 mm	
Backlighting:	active (white LED)	
Touch area:	resistive 4-conductor	
Diagonal:	3.5"	
Control:	touch	
<b>Power supply</b>		
Supply voltage:	100-230 V AC	from the back 100 – 230V AC, from the side 12V DC
Input power:	max. 5W	
Power supply terminals:	A1 - A2	
<b>Control</b>		
Communication protocol:	RFIO	
Frequency:	866–922 MHz (for more information see p. 80)	
Range:	in open space up to 100 m	
Min. distance RF Touch - Actuator:	1 m	
<b>Connection</b>		
Connection:	terminal box	no-screw push-in terminal box or jack Ø 2.1 mm jack connector
Cross-section of connecting wires:	max. 2.5 mm <sup>2</sup> /1.5 mm <sup>2</sup> with a hollow	
<b>Operating conditions</b>		
Operating temperature:	0 to +50°C	
Storage temperature:	- 20 to +70°C	
Protection:	IP20	
Overvoltage category:	III.	
Contamination degree:	2	
Operating position:	any	
Installation:	an installation box	anywhere indoor
Dimensions:	94 x 94 x 36 mm	94 x 94 x 24 mm
Weight:**	127 g	175 g
Related standards:	EN 60730-1	

### Power supply

#### RF Touch-B



#### RF Touch-W

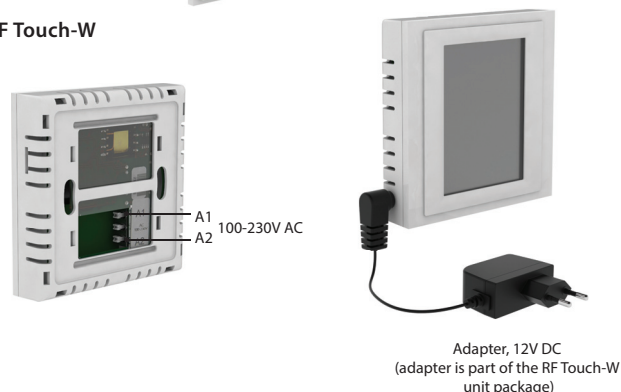

### Colour combinations



black / white



chrome / grey



white / pearly



glass / grey



red / aluminum



aluminum / dark grey



titanium / ice

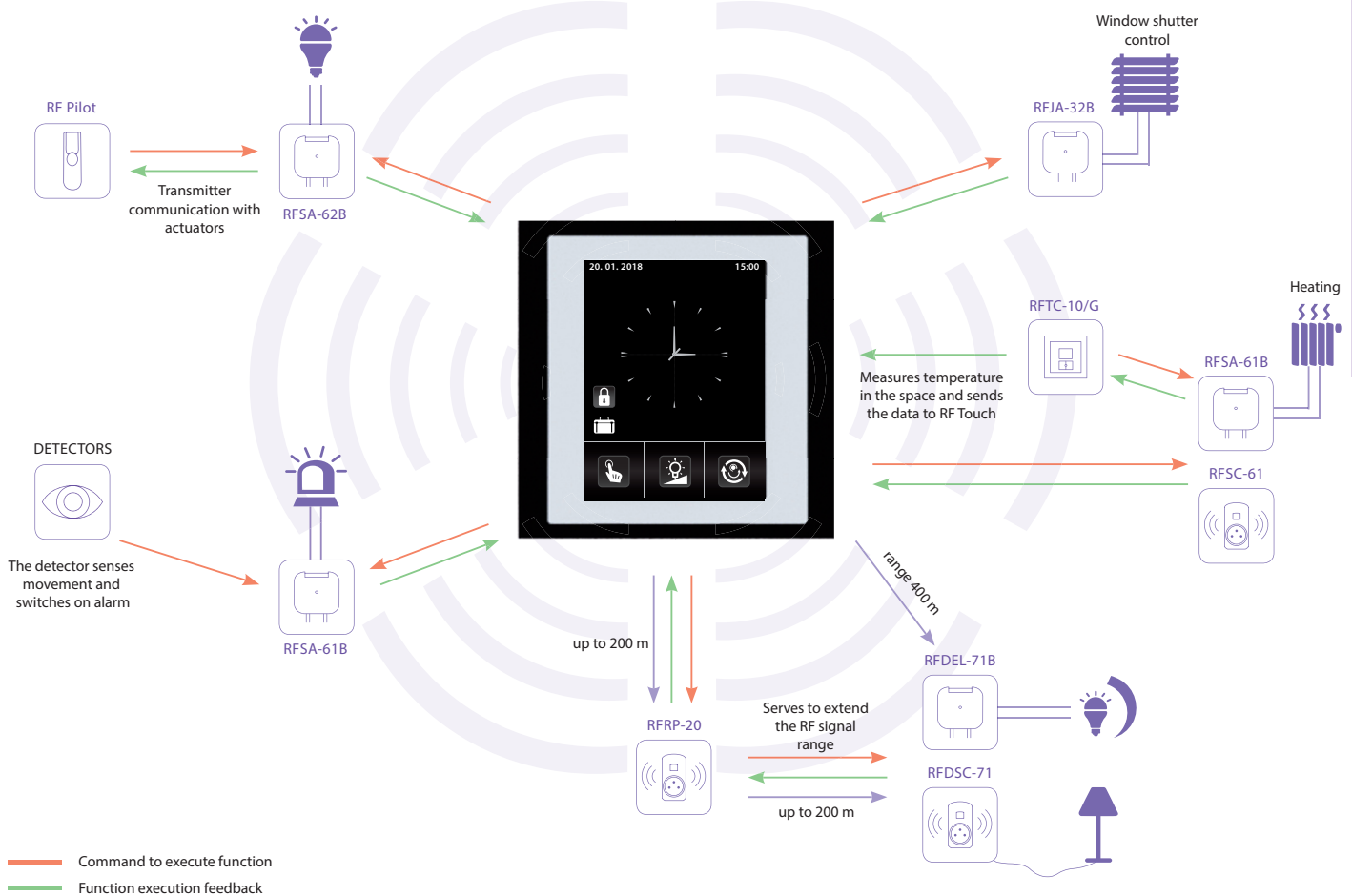

## HEATING

- control of heating devices (boilers, thermo valve 0–10 V...)
- temperature regulation in the entire house or in individual rooms
- information about outdoor temperature (wireless temperature sensor) - terraces
- possibility to set your own heating program for the whole week
- holiday mode will interrupt the heating program when you are on holiday
- room temperature correction (during the heating program) is performed with a digital thermal regulator command

## DIMMING

- the regulation of light intensity
- customizable names of individual dimmed circuits (such as "living room lights")
- "sunrise/sunset" imitation - light gradually goes on or off during the preset period between 2 s and 30 min

## DETECTORS

- RF Touch communicates with detectors - window, door, movement...
- possible to combine with switching actuators
- clear control over the entire house

## SWITCHING

- this function serves to switch on/off lights, sockets, electrical appliances and devices
- intuitive control thanks to customized name options
- switch clock enabling you to switch appliances in real time, even during your absence (simulation of the presence of persons, etc.)
- switching actuator function selections: switch on/off, impulse relay, button, delayed ON/OFF (time of delay from 2 s to 60 min)

## WINDOW SHUTTERS

- controlling window shutters, sunblinds, blinds, garage door, etc.
- window shutters are controlled separately or as a group
- setting an independent time schedule for pulling up/down
- the window shutter receivers are powered by either 230 V or 24 V DC (shutters between windows, etc.)

## QUICK CONTROL

- serves to control group of actuators with a single touch
- possibility to set up scenes; on activation, for example, window shutters are pulled down and lights are adjusted to required intensity



- This signal repeater is used to extend the range between the controller and unit by up to 200 meters.
- It is designed to transmit a signal to up to 20 units.
- Indication:
  - green LED - supply voltage
  - red LED - active status (receiving and transmitting an RF signal)
- Programming is performed by a button.
- Communication frequency with bidirectional protocol RFIO.
- Thanks to the socket design, installation is simple by direct insertion into the existing socket, the throughsocket function remains unchanged.

Technical parameters	RFRP-20/230V	RFRP-20/120V
Supply voltage:	230 - 250 V	120 V AC
Supply voltage frequency:	50-60 Hz	60 Hz
Apparent input:	6 VA	
Dissipated power:	0.7 W	
<b>Control</b>		
Communication protocol:	RFIO	
Frequency:	866-922 MHz (for more information see p. 80)	
Range:	in open space up to 200 m	
Minimum control distance:	20 mm	
Programming:	button - green LED/red LED	
<b>Other data</b>		
Operating temperature:	-20 to +55 °C	
Storage temperature:	-30 to +70°C	
Mounting:	plug into a socket	
Protection:	IP20 Device	
Dimensions:	60 x 120 x 80 mm	
Weight:	225 g	
Related standards:	EN 607 30-1 ED.2	

Produced in 5 designs of sockets/plugs:



Signal transmission and extension for up to 20 components.

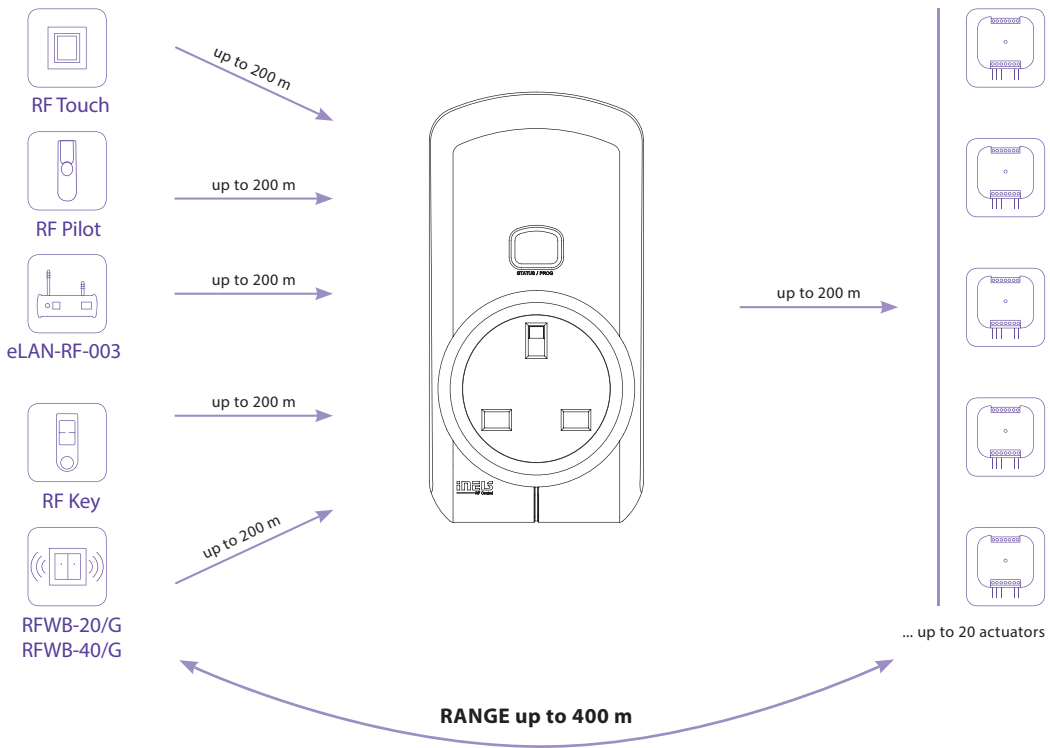





- The smart RF box allows you to connect to a LAN network and then subsequently control the installation of iNELS RF from a smartphone, tablet, watch, Samsung TV, voice assistant (Google Home and Alexa), another device or third-party SW.
- It transmits and receives commands of up to 40 units, and it processes set programs for automatic control.
- Thanks to bidirectional communication, it visualizes the current status of individual units.
- The smart RF box eLAN-RF-003 is connected by network cable LAN to the home network (router).
- Power supply via 10-27 V DC (included) or PoE 24 V DC.
- Option of setting via web interface or directly in the application iHC.
- The package includes an internal antenna AN-I , in case the Smart RF box is located in a metal switchboard, you can use the external antenna AN-E for better signal reception.
- Range up to 100 m (in open space), if the signal is insufficient between the Smart RF box and unit, use the signal repeater RFRP-20 or protocol component RFIO2 that support this feature.
- Communication frequency with bidirectional protocol RFIO2.

Technical parameters		eLAN-RF-003
<b>Interface RF Control</b>		
Communication protocol:	RFIO	
Broadcasting frequency:	866–922 MHz (for more information see p. 80)	
Signal transfer method:	two-way addressed message	
Output for antenna:	SMA connector*	
Antenna RF:	1 dB (part of supply)	
Indications RF communications:	1 x red RF status LED	
Range:	in open space up to 100 m	
<b>Interface Ethernet</b>		
ETH operating status indicator:	green LED	
ETH communication indicator:	yellow LED	
Communications interface:	100 Mbps (RJ45)	
Preset IP address:	192.168.1.1 or DHCP	
<b>Power</b>		
Supply voltage/current:	10-27 V DC / 200 mA SELV	
Power:	adapter with connector Jack Ø 2.1 mm (part of supply), Poe 24 V DC or connector USB-B	
Supply voltage indication:	green LED POWER	
Button RESET:	settings to their defaults	
Power source:	230 VAC / 12 V DC part of supply of device	
<b>Other data</b>		
Operating temperature:	-20 to +50 °C	
Storage temperature:	-25 to +70 °C	
Protection:	IP20	
Contamination degree:	2	
Working position:	any	
Dimensions:	90 x 52 x 65 mm	
Weight:	136 g	

\* Max Tightening Torque for antenna connector is 0.56 Nm.

Device description

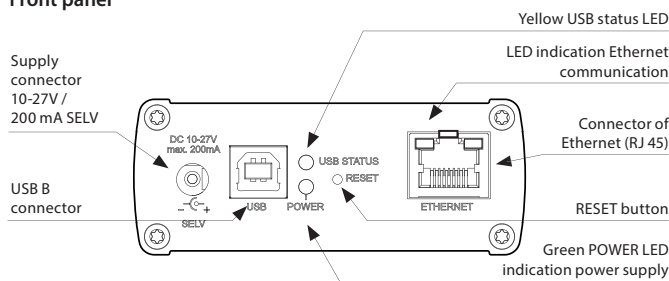

Front panel

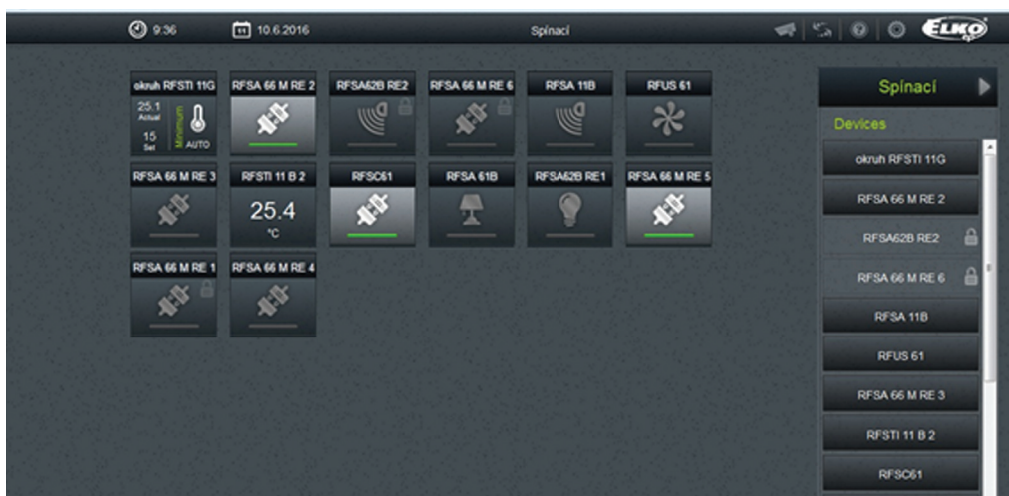
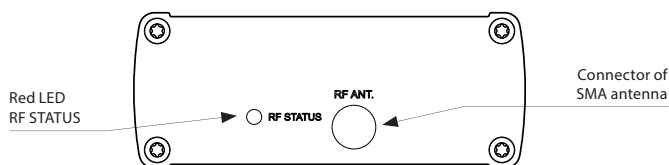

Back panel

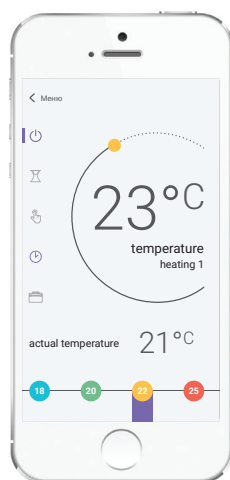

## Smartphones

 iHC-MAIRF

 iHC-MIIRF

- Control application for smart phones with Android operating system - iHC-MAIRF and for smart phones iPhone - iHC-MIIRF.
- The application iHC-MAIRF/iHC-MIIRF allows you to control your home easily by smartphone.
- The user-friendly and intuitive application environment offers central control from one place.
- iHC-MAIRF/iHC-MIIRF enables control of RF units by smart phone via a smart RF box, which is connected to the home Internet network.
- The smart RF box controls up to 40 units of iNELS RF Control, (you can gradually expand control from 1 unit of iNELS RF Control).
- If you don't have a permanently set IP address, the application supports its automatic obtaining from the DHCP server.
- Functions of the application iHC-MAIRF/iHC-MIIRF:
  - regulation of hot water or electric underfloor heating (setting a weekly program)
  - measuring temperature (e.g. by wireless sensors)
  - switching appliances (garage door, blinds, fans, sprinklers, sockets, etc.)
  - dimming lights (LED, energy-saving, halogen lamps or classic light bulbs)
  - time switching (delayed switching off of light when leaving room)
  - integration of video cameras
  - light scenes (one press to perform multiple commands simultaneously)
  - remote control (switch on heating before returning from vacation).
- The application iHC-MAIRF supports Android versions from 2.3 in your smartphone.

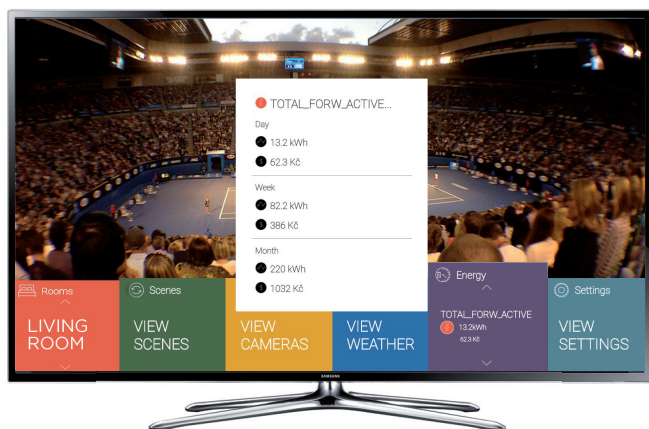
## Smart TV



- eLAN-RF allows to control appliances using Smart TV application called iHC-SMTV which can be easily installed to your TV.
- Operation with conventional control of TV.
- Any Smart TV using Tizen OS made in 2015 or earlier is compatible with application.
- Functionality:
  - switching ON/OFF, automatic timing
  - dimming ON/OFF, smooth start/stop, change colour
  - scenes
  - form of heating temperature indication (to make changes directly in the smart phone application)
  - camera (possibility to stream live images if it is supported by a Web browser on the SMART TV).
- Form control is free and is not licensed.
- App download:



## Smart watch Samsung GEAR S2 / S3

 iHC-WTRF

- Applications to control appliances via smart watches Samsung Gear S2/S3.
- Smart watches are associated with the controlled appliances through RF smart box eLAN-RF.
- Functionality:
  - switching appliances, sockets
  - automatic timing
  - dimming the lights, adjust the colour
  - control garage doors, gates, gates and shutters
  - features scenes for group commands.
- Intuitive and easy to control in many combinations, touching the display and moving wheels on Samsung Gear S2/S3.
- The setting is done by applying iNELS Home Control iHC-MAIRF directly or via a web interface RF smart box eLAN-RF.
- It is not necessary to carry a smart phone to control, the watch functions independently.

Amazon Alexa



amazon alexa

- With Alexa Artificial Intelligence, you can simplify your daily life by setting an alarm, notifications, creating new items, or reminders in your calendar.
- The voice assistant can answer questions and control individual devices and smart homes.
- It is available on mobile phones, TVs, smart speakers and other devices.
- The voice assistant is designed to comfortably control the RF Control wiring by voice using your mobile phone.
- As a complement to RF Control, iNELS Smart Home Solution blends in with every modern home.

Google Home Voicea



Google HOME

- Google Home can become a member of your smart home family.
- It communicates with the smart eLAN-RF box via the Cloud connection.
- This allows you to control, for example, the temperature setting or the light intensity by voice.
- The voice assistant is designed to conveniently control the RF Controlled electro-installations by voice using your mobile phone or smart speaker.
- As a complement to RF Control, iNELS Smart Home Solution blends in with every modern home.

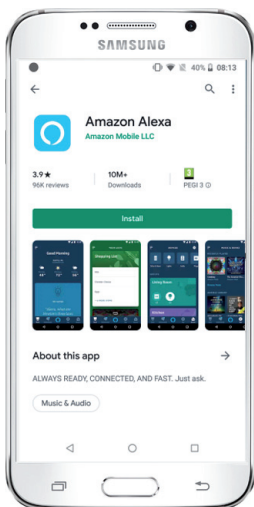

Register to the Cloud via email and set a password.

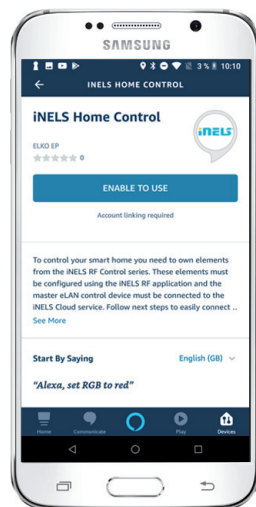

Preview the Google home app on Google Play.

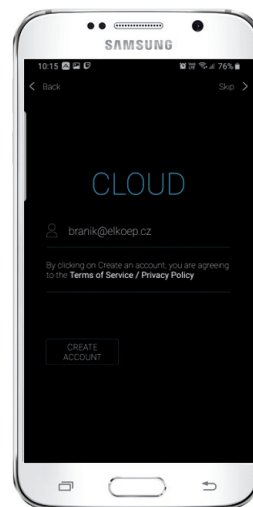

Preview the Amazon Alexa app on Google Play.

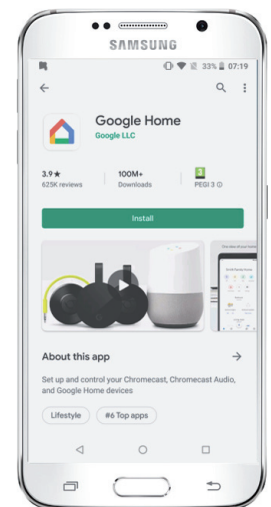

Setting up products in iNELS Home Control.

Application iHC-MAIRF-Cloud / iHC-MIIRF-Cloud:

- Designed for iOS 10+ and Android 5.0+.
- Optimized for devices with 800x480 screen resolution.
- The language of the application changes automatically according to the language set in Android / iOS.
- You can create a cloud account using the Setup Wizard or the login button in the main menu. The recommended minimum speed for connecting the eLAN-RF to the Cloud should be in the order of megabytes per second (3G - 1Mbit / s and higher).



- The energy gateway is a central device for assessing energy consumption (electricity, water, gas, heating).
- The Energy Gateway receives data in the following ways:
  - a) Pulse inputs (2 inputs) for direct connection to 50 meter outputs
  - b) Wireless RFTM-1 converters (up to 8 pcs), which read pulses from meters, either directly (outputs S0) or by scanning measurement indicators (dial, flashing LED, magnetic tag and wirelessly transmits them to RFPM-2M. Suitable probes (LS, WS, MS) are used, which are part of the RFTM-1 offer.
  - c) Through current transformers CT-50 (up to 3 inputs), through which the phase conductors are passed.
  - d) Potential-free contact of the tariff (2 inputs = 4 tariffs).
- Connection to the data network is made by means of LAN Ethernet connector or wirelessly via a Wi-Fi network.
- Monitored data is stored on internal memory storage.
- By means of the application iHC and cloud connection, it is possible to maintain online access to data and monitoring history.
- Possibility to set the response to the set level - closes the relay.
- The power supply of the device is provided from the monitored phase L1.
- Range up to 100 m (in open space), if the signal between the controller and the user is weak, use the signal repeater RFRP-20 or protocol component RFIO2 that supports this feature.
- Communication frequency with bidirectional protocol RFIO.
- 3-module design, mounted on a DIN rail into the switchboard.

## Connection

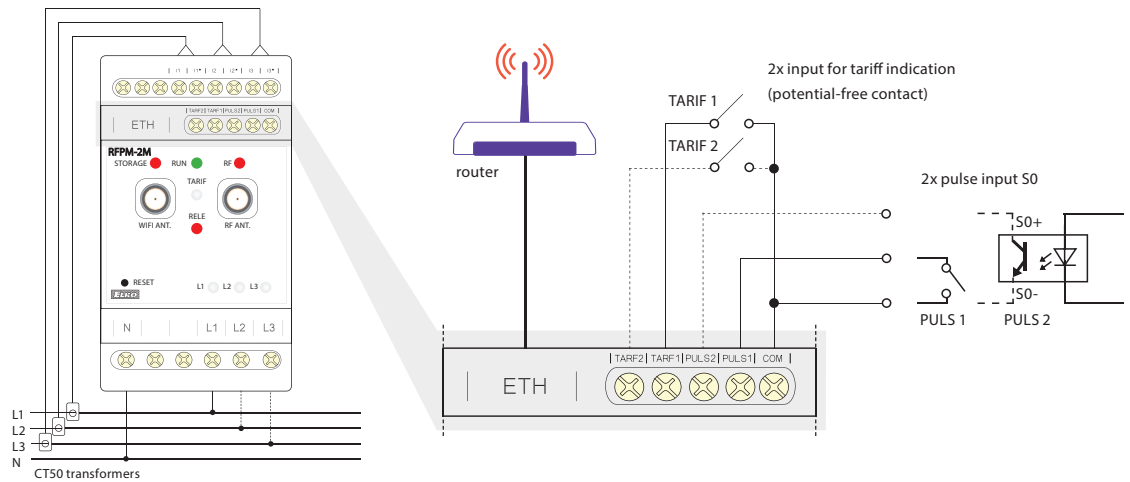

## Device description

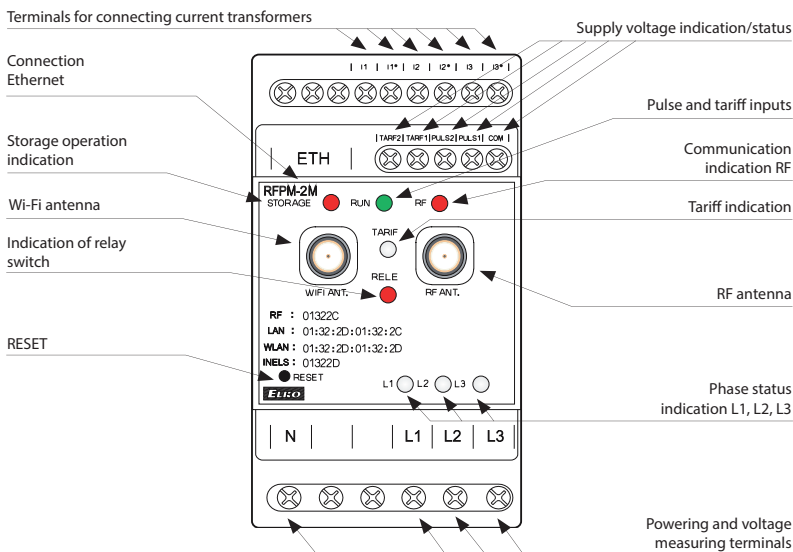

### Tariff indication - RGB LED

TARIF 1:	red
TARIF 2:	green
TARIF 3:	blue
TARIF 4:	yellow

### Phase status indicator L1, L2, L3 - R/G LED

failure (outage):	red
active phase:	green
unmonitored phase:	LED off

Technical parameters		RFPM-2M
Supply/measured voltage:	230 V AC / 50-60 Hz, 1f / 3f +N	
Supply voltage tolerance:	+15/-20%	
Closed relay power input:	5 VA	
Switching voltage level:	140 V, +10/-20%	
RF Control interface		
Communication protocol:	RFIO	
Frequency:	866-922 MHz (for more information see p. 80)	
Signal transfer method:	two-way addressed message	
Output for antenna:	SMA - FEMALE*	
Antenna RF:	1 dB (part of suply)	
Range:	in open space up to 100 m	
Control		
Controlling:	Bootloader (press >2 s)	
Button Reset:	Unit reset (press >10 s)	
Interface Wi-Fi		
Wi-Fi mode:	AP Bridge / AP LAN / Client	
Standard:	IEEE 802.11 b/g/n / 2.4 GHz	
Wi-Fi Security:	WEP, WPA-PSK, WPA2-PSK	
Frequency range Wi-Fi:	RP - SMA - FEMALE*	
Antenna Wi-Fi:	1 dB (part of suply)	
Range:	up to 20 m	
Interface Ethernet		
Connection:	static IP / DHCP Client	
Transfer speed:	10 / 100 Mbit / s	
Connector:	RJ45	
Preset IP address/IP address of bootloader:	192.168.1.2	
Measuring		
Pulse inputs:	PULS1 (S0), PULS2 (S0)	
Tariff inputs:	TARF1, TARF2 - binary combination	
Option of switching inputs:	switching by contact / opening by collector	
Separation by isolation of power and control circuits:	reinforced insulation (Cat. II surges by EN 60664-1)	
Probes measuring current:	3x CT50	
Wireless consumption sensor:	RFTM-1	
Measuring circuit		
Network:	1f-3f	
Frequency:	50 - 60 Hz / ±10 %	
Accuracy:	Class 1.0	
Current measuring coil:	max. 50 A (current transformer CT50)	
Wire diameter:	max. 16 mm	
Other data		
Working temperature:	-20 to + 35°C	
Storage temperature:	-30 to +70°C	
Operating position:	vertical	
Mounting:	DIN rail EN60715	
Protection:	IP20 from front panel / IP40 in cover	
Overvoltage category:	II.	
Degree of pollution:	2	
Cross-section of connecting wires (mm <sup>2</sup> ):	max. 1x 2.5, max. 2x 1.5 / with a hollow max. 1.5	
Dimension:	90 x 52 x 65 mm	
Weight:	125 g	

\* Max Tightening Torque for antenna connector is 0.56 Nm.

**Methods of sensing meters**

**CT (Current transformer)**

Opening pliers open/close on the existing wire of the measured circuit, most frequently at the main supply at the electricity meter.

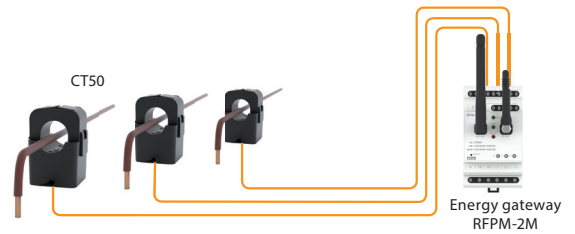

**LS (LED sensor)**

The LED sensor scans LED impulses on the meter, which indicates consumption by flashing.

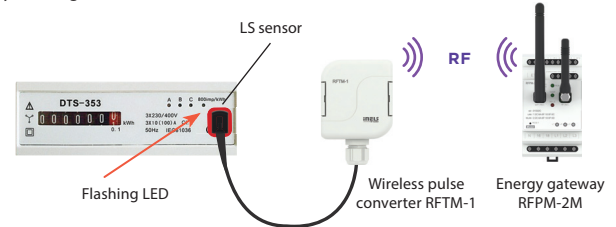

**MS (Magnetic sensor)**

The magnetic sensor scans movement of the numeral, upon which a permanent magnet is placed.

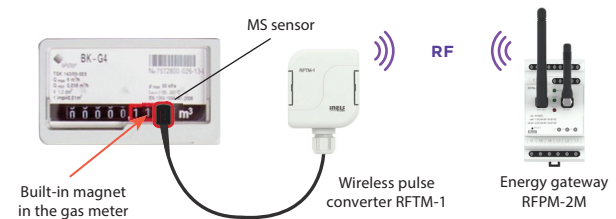

**WS (Magnetic sensor for water meter)**

The magnetic sensor detects the pulse that is created with each rotation of the magnet placed on the unit dial.

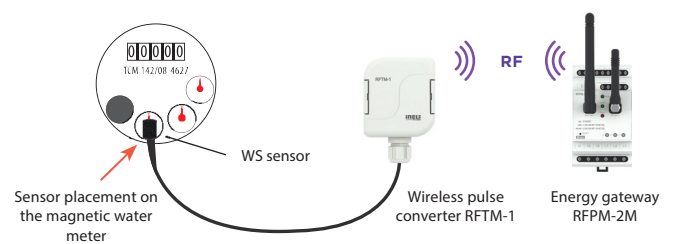

**IMP (Output „S0“)**

Meters with impulse output indicated as „S0“ connected by wires to terminals GND and DATA1 on the sensor RFTM-1.

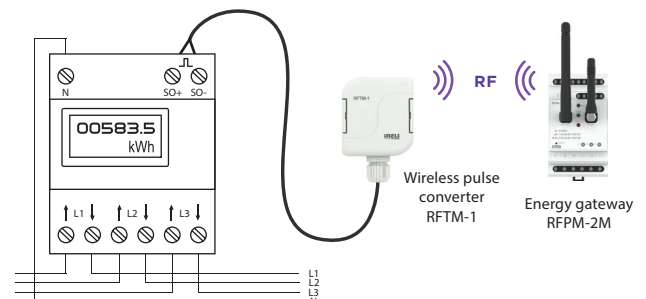



- The wireless pulse converter detects home energy meters (electric, water, gas) by means of sensors, and sends them to the wireless unit RFPM-2M.
- The energy gateway RFPM-2M acts as an interface between the meter and a smartphone.
- Measured values are displayed in the application iHC-MAIRF/iHC-MIIRF, in daily, weekly or monthly overview in graphs.
- The sensor is designed for use on existing meters and even without the impulse output "S0" (The gauge must support scan).
- RFTM-1 transfers consumption from meters using sensors - LS (LED sensor), WS (Magnetic sensor for meter), MS (Magnetic sensor) or by impulse output („S0“).
- For each consumption meter, it is necessary to have one pulse converter RFTM-1.
- Battery power (2x 1.5 V AAA batteries - included in package) with average battery life of around 2 years (according to the type of scan, frequency of transmissions and pulses).
- Range up to 100 m (in open space), if the signal between the controller and the user is weak, use the signal repeater RFRP-20 or protocol component RFIO2 that support this feature.
- Communication frequency with bidirectional protocol RFIO.
- The increased IP65 protection is appropriate for mounting in risers, switchboards and other demanding environments.

Technical parameters		RFTM-1
Power supply:	2x 1.5 AAA batteries	
Battery Life:	Appr. 2 years, (depending on the type of sensor, frequency of transmissions and pulses)	
Indication		
Setting mode:	Green LED flashes - active Red LED - flashes during impulse sensor registration	
Communications Test - RF STATUS:	Green LED - communication OK Red LED - communication ERR	
Normal operation:	no indication	
Control		
Manual control:	button SET	
Sensor Selection:	rotary potentiometer	
Supported sensors (not included in the package):	LS (LED sensor) MS, WS (magnetic sensor) S0 (Contact, open collector, reed magnetic contacts)	
Output		
Communication protocol:	RFIO	
Frequency	866–922 MHz (for more information see p. 80)	
Range:	in open space up to 100 m	
Other data		
Working temperature:	-20 to +50 °C *	
Storage temperature:	-30 to +70°C	
Operating position:	any	
Protection:	IP65	
Cross-section of connecting wires:	max. 0.5 - 1 mm <sup>2</sup>	
Dimension:	72 x 62 x 34 mm	
Weight:	104 g	

\* Pay attention to the operating temperature of batteries.

#### Device description

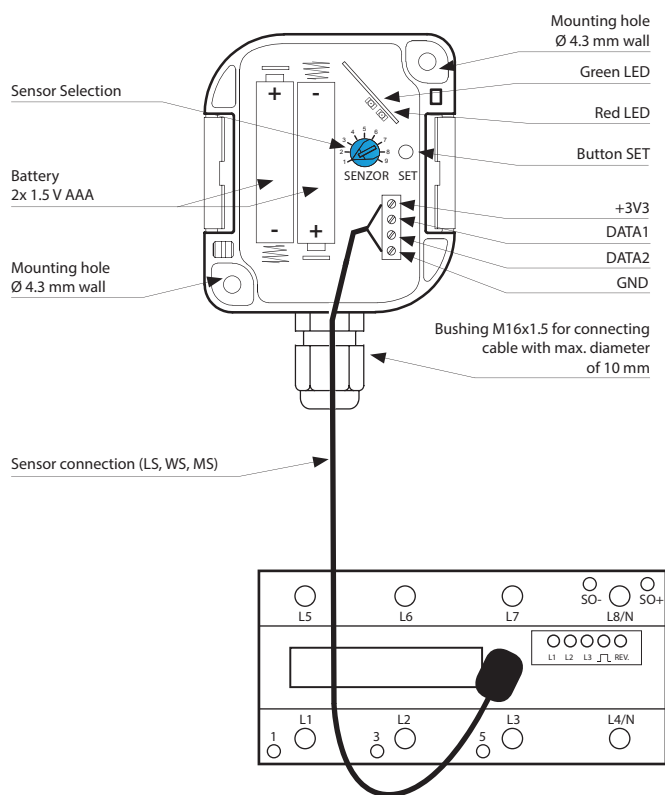



- Current Transformer - CT50 has open clips, which can be opened and closed. This design allows a current transformer to be placed on the existing measuring circuit wire, usually at the main flow of the meter.

Technical parameters	CT50
Current:	50 A
Output:	16.66 mA
Conversion ratio:	3000:1
Accuracy:	1 %
Dielectric strength, Ferrite cores/secondary winding:	2000 V AC / 1 min
Frequency:	50 - 60 Hz
<b>Other data</b>	
Operating temperature:	-15 to 60 °C
Storing temperature:	-30 to 90 °C
Flammability:	UL 94 - V <sub>0</sub>
Max. diameter through the conductors:	16 mm
Dimension (w x h x d)/ cable leads:	31 x 46 x 32 mm / 1 m
Weight:	86 g



- The LED sensor scans LED impulses on the meter, which indicates consumption by flashing.
- The LED sensor is particularly suitable for power meters that support LED pulse sensing (the LED on the meter is marked "imp").
- The sensor's scanner is affixed with glue above the LED diode of the meter signaling indication of consumption.
- The sensor is connected to the internal terminal of the RFTM-1 converter.

Technical parameters	MS
Voltage range:	1.6 to 3.6 V
Consumption	7uA *
Output load:	max. 3mA
Scanning period:	100ms
Switch sensing sensitivity (output L):	±(2.3 to 4.7)mT
Opening detection sensitivity (output->H):	±(0.9 to 3.8)mT
Hysteresis:	1mT
Working temperature:	-40 to 80 °C
<b>Other data</b>	
Cross-section of connecting wires:	max. 3.5 mm
Wire length:	1.5 m
Protection:	IP20

LS | LED sensor



- The LED sensor scans LED impulses on the meter, which indicates consumption by flashing.
- The LED sensor is particularly suitable for power meters that support LED pulse sensing (the LED on the meter is marked "imp").
- The sensor's scanner is affixed with glue above the LED diode of the meter signaling indication of consumption.
- The sensor is connected to the internal terminal of the RFTM-1 converter.

Technical parameters	LS
Voltage range:	2.5 to 3.7V
Minimum consumption (idle mode):	0.5uA *
Maximum power consumption (pulses 100Hz):	max. 2uA *
Working temperature:	-20 to 50 °C
<b>Other data</b>	
Cross-section of connecting wires:	max. 3.5 mm
Wire length:	1.5 m
Protection:	IP20

Sensor LS responds only to light pulses, i.e. it does not detect static state LEDs.

WS | Magnetic sensor for water meter

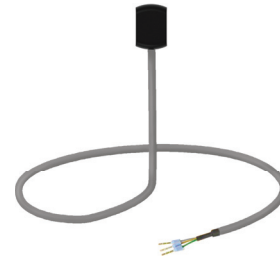

- A magnetic sensor that detects the pulse that is created by each rotation of the magnet placed on the unit dial meter.
- The WS sensor is especially suitable for water meters that support magnetic sensing.
- The sensing sensor is glued over the circular unit face of the gauge (the scanning dial is different from the other indicators, e.g. the white arrow wheel).
- The sensor is connected to the internal terminal of the RFTM-1 converter.

Technical parameters	WS
Voltage range:	1.65 to 5.5V
Consumption:	1.5uA *
Output load:	max. 150uA
Switch sensing sensitivity:	±(0.3 to 1.1)mT
Opening detection sensitivity:	±(0.2 to 0.9)mT
Hysteresis:	0.2mT
Working temperature:	-40 to 80 °C
<b>Other data</b>	
Cross-section of connecting wires:	max. 3.5 mm
Wire length:	1.5 m
Protection:	IP20

\* Measured at 3V, no load output.

The Energy Gateway RFPM-2M web interface now has a completely new and cleaner visualization. This makes displaying and evaluating energy consumption even more convenient and easy.

DEMO web interface

<http://217.197.144.56:2130/>

Login and password: **admin**



### STATISTICS

- Sample overview of electricity consumption (today, yesterday, this week, this month)
- Consumption converted to finance costs
- Graphical visualization of consumption (by hours, days, months)

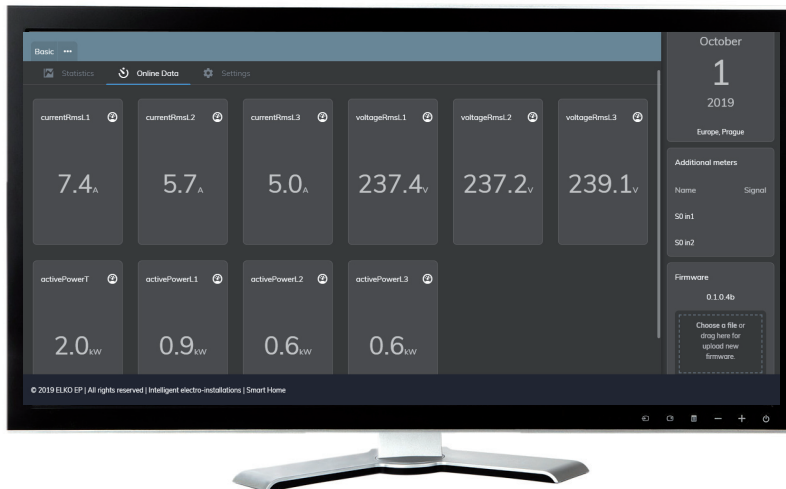

### ONLINE DATA

The Energy Gateway evaluates the following indicators in the network:

- Phase current/voltage
- Phase overvoltage/undervoltage
- Asymmetry
- Distortion of the sine wave signal
- Distortion of sine wave signal flow
- Frequency
- Active performance
- Reactive power
- Apparent performance
- Power factor
- Phase voltage shift between phases

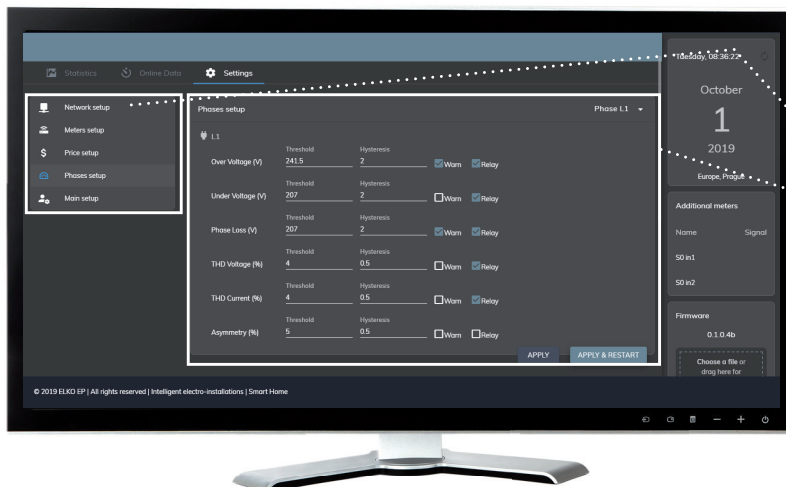

### SETTINGS

- Main SETTINGS menu
- Example of "Phase settings" submenu

All basic and advanced settings are made simply, quickly and intuitively. If you have any questions, a telephone/e-mail technical support is available.



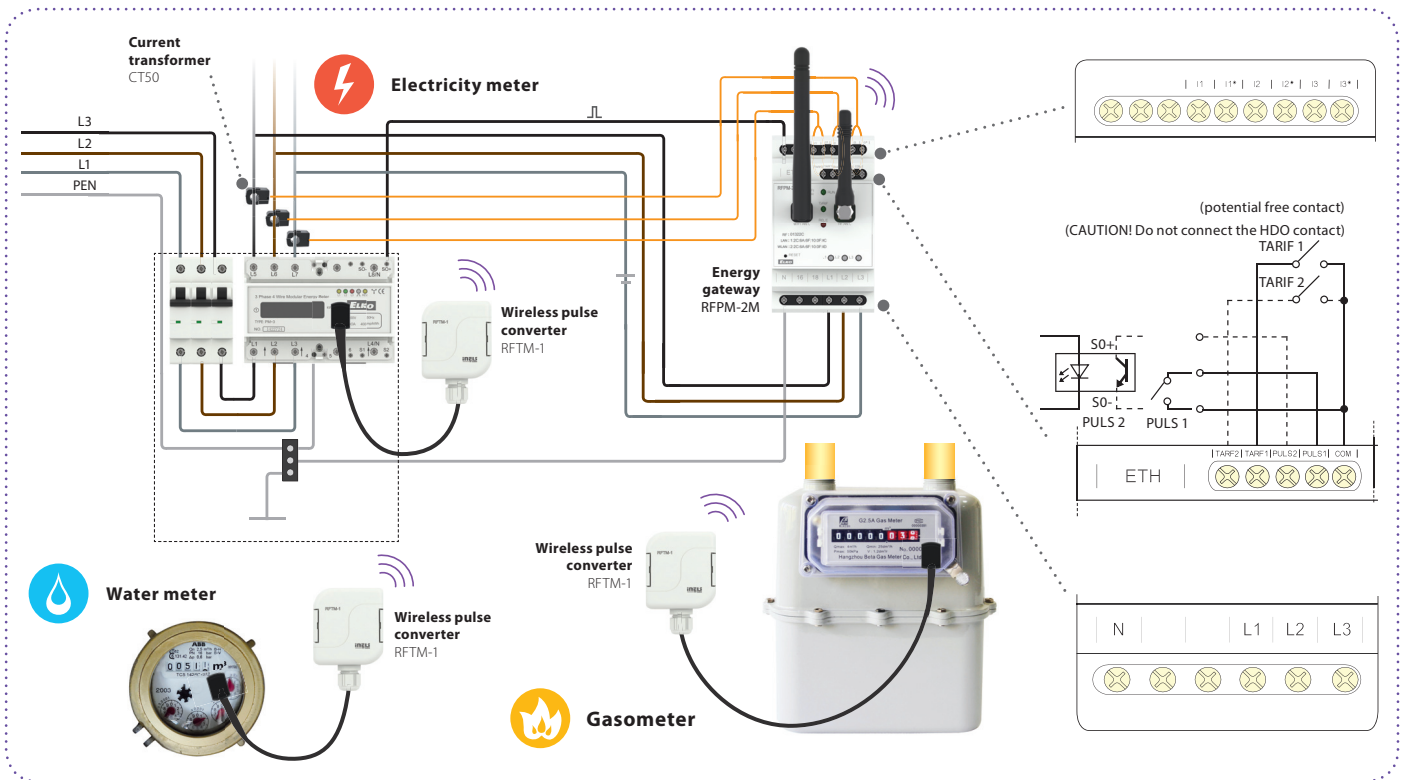

Measured data can be displayed not only through the web interface on the PC, but also in iNELS Home Control (iHC). The measured values of all quantities can be monitored, but above all archived and analysed in many selected time periods (daily, weekly, monthly and yearly). Consumption can be quantified in consumed units or directly in financial costs. Another advantage is the possibility of measuring electricity consumption in up to 4 tariffs.

PROMO APP available

Login and password: **admin**



Current consumption can be displayed as a bar graph.

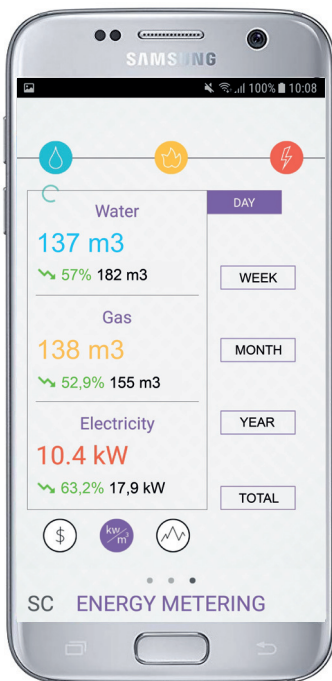

You can choose to display the consumption in units.

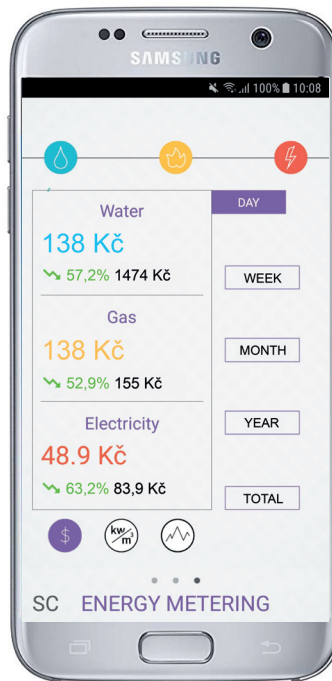

One click to switch to power consumption in your currency.

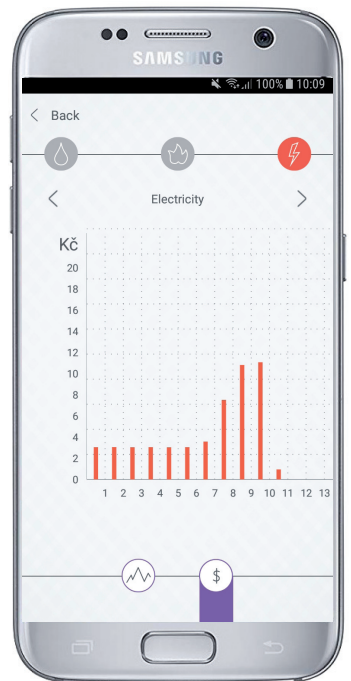

Significant savings can be achieved by analysing data.

# Hotel Room Energy Saving Kit

Costs saving, Increased comfort



[www.inels.com](http://www.inels.com)

**iNELS**<sup>®</sup>

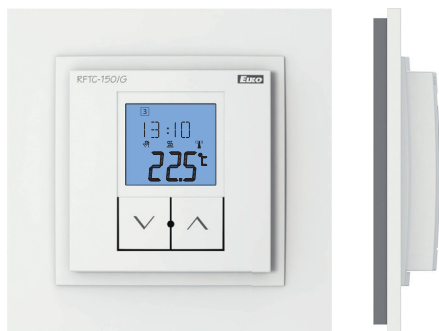

- The wireless controller RFTC-150/G measures the room temperature by internal sensor. On the basis of a set program it sends commands to the switching component RFSA-166M Switching fan coil.
- It is possible to set automatic or manual mode.
- Range of measured temperature 0 to 55 °C.
- The backlit LCD display displays the current and set temperature, status (ON/OFF), battery status, day of the week, current time, etc.
- Battery power (2x 1.5 V AAA batteries - included in supply) with battery life of around 1 year based on frequency of use.
- The flat rear side of the device enables its placement anywhere in the room.
- Components support communication with RF detectors.
- Range up to 100 m (in open space), if the signal is insufficient between the controller and unit, use the signal repeater RFRP-20 or protocol component RFIO2 that support this feature.
- Communication frequency with bidirectional protocol RFIO.
- Colour combination of temperature unit in design of frames LOGUS<sup>90</sup> (plastic, glass, wood, metal, stone).

Technical parameters		RFTC-150/G
Supply voltage:	2x 1.5 V AAA batteries	
Battery life:	up to 1 year based on frequency of use	
Temperature correction:	2 buttons √ / ^	
Temperature offset:	± 5 °C	
Display:	LCD, characters	
Backlighting:	active 10 s after pressing	
Transmission indication/function:	symbols	
Temperature measurement input:	1x internal sensor	
Temp. measurement range and accuracy:	0 to + 55 °C ; 0.3 °C of the range	
Control		
Communication protocol:	RFIO	
Frequency:	866–922 MHz (for more information see p. 80)	
Repeater function:	NO	
Signal transmission method:	bidirectionally addressed message	
Range:	in open space up to 100 m	
Minimum control distance:	20 mm	
Other data		
Max. number of controlling actuators RFSA-166M:	1	
Program:	Weekly	
Operating temperature:	0 to + 55 °C	
Operating position:	on the wall	
Mounting:	by gluing/screwing	
Protection:	IP30	
Contamination degree:	2	
Dimensions		
- plastic:	85 x 85 x 20 mm	
- metal, glass, wood, granite:	94 x 94 x 20 mm	
Weight:	66 g (without batteries)	
Related standards:	EN 60669, EN 300 220, EN 301 489 directive RTTE Directive, Order. No 426/2000 Coll. (Directive 1999/EC)	

Connection

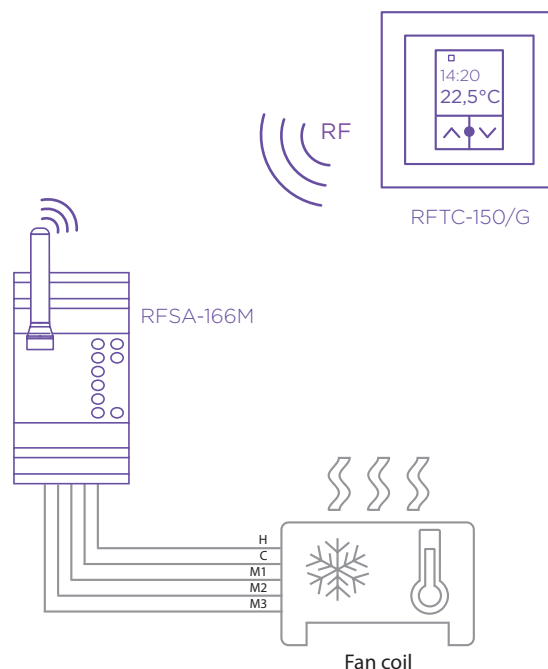

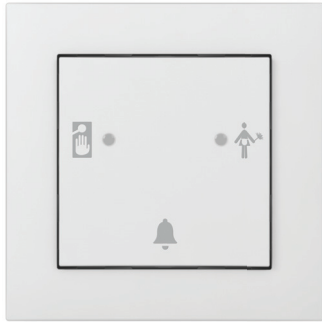

- RFPCR-31/G is a wall-mounted card reader that is designed for read contactless media (smart cards, key chains, etc.), which are used for controlling access to buildings or their parts.
- The reader sends a wireless command to switch, signaling, bell, etc. This makes it suitable for reconstruction, where the main benefit is the installation speed.
- RFPCR-31/G reader can be used to control the security system (locking/unlocking) access system (opening doors, gates, etc.) or appliances (based on assigned rights).
- RFPCR-31/G supports RFID media with the carrier frequency of 13.56 MHz. Supported card types MIFARE Ultralight, DESFire 2K (EV1), DESFire 4K (EV1) .
- RFPCR-31/G is also equipped with 8 A relay output with changeover contact  $\text{AgSnO}_2$ , by which controlled devices can be switched directly.
- Range up to 160 m (in open space), if the signal is insufficient between the card reader and unit, use the signal repeater RFRP-20 or protocol component RFIO2 that support this feature.
- Communication frequency with bidirectional protocol RFIO.
- Wall card reader RFPCR-31/G is compatible with both types of frames LOGUS<sup>90</sup> (85.6 x 85.6 or 94 x 94 mm), therefore you can combine them with double and triple frames and classic products of the series.

### Technical parameters

### RFPCR-31/G

Supply voltage:	110 - 230 V AC
Supply voltage frequency:	50 - 60 Hz
Dissipated power:	max. 2.5 W
Apparent input:	max. 5 VA

### Buttons

Number of control buttons:	2
----------------------------	---

### RFID readers

Supported frequencies:	13.56 MHz
Card Type:	MIFARE Ultralight, DESFire 2K (EV1), DESFire 4K (EV1)

### Outputs

Output:	1x changeover 8A / $\text{AgSnO}_2$
Indication:	two-colour LED (red, green)
Acoustic output:	piezo-changer
Switching voltage:	230V AC / 30V DC
Switching output:	2000 VA / AC1; 240 W/DC
Peak current:	20 A / <3s
Insulation voltage between relay outputs and internal circuits:	3.75 kV, SELV according to EN 60950
Minimal switched current:	10 mA / 10 V
Switching frequency without load:	300 min <sup>-1</sup>
Switching frequency with rated load:	15 min <sup>-1</sup>
Mechanical life:	1x 10 <sup>7</sup>
Electrical life AC1:	1x 10 <sup>5</sup>

### Control

Communication protocol:	RFIO
Frequency:	866–922 MHz (for more information see p. 80)
Repeater function:	NO
Range:	in open space up to 160 m

### Connection

Network:	max. 2.5 mm <sup>2</sup> /1.5 mm <sup>2</sup> with sleeve
----------	---

### Other data

Operating temperature:	-20 to +55 °C
Storing temperature:	-30 to +70 °C
Protection degree:	IP20
Overtoltage category:	II.
Pollution degree:	2
Operation position:	any
Installation:	into installation box
Dimensions	
- plastic:	85.6 x 85.6 x 42 mm
- metal, glass, wood, granite:	94 x 94 x 36 mm
Weight:	68 g (without frame)

### Connection

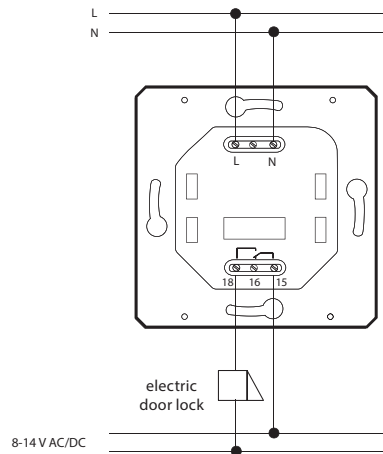

### Device description

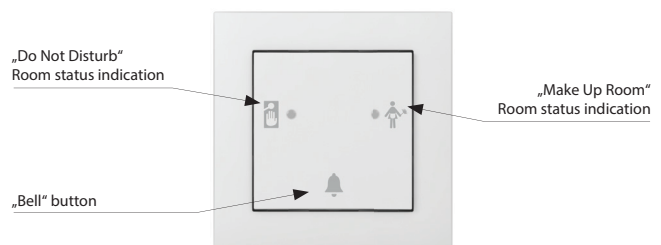



The picture of device is illustrative, the icons (symbols) are configurable by the customer.

Technical parameters	RFGCR-31/W	RFGCR-31/B
Supply voltage:	110 - 230 V AC	
Supply voltage frequency:	50 - 60 Hz	
Dissipated power:	max. 2.5 W	
Apparent input:	max. 5 VA	
<b>Input</b>		
Illuminance sensor:	1 ... 100 000 Lx	
<b>Buttons</b>		
Number of control buttons:	3	
Type:	capacitive	
Indication:	coloured illuminated symbol	
<b>RFID readers</b>		
Supported frequencies:	13.56 MHz	
Card Type:	MIFARE Ultralight, DESFire 2K (EV1), DESFire 4K (EV1)	
<b>Outputs</b>		
Signalling:	Do Not Disturb, Make Up Room	
Output:	1x changeover 8 A / AgSnO <sub>2</sub>	
Acoustic output:	piezo-changer	
Tactile output:	Vibration motor	
Switching voltage:	230V AC / 30V DC	
Switching output:	2000 VA / AC1; 240 W/DC	
Peak current:	20 A / <3s	
Insulation voltage between relay outputs and internal circuits:	3.75 kV, SELV according to EN 60950	
Minimal switched current:	10 mA / 10 V	
Switching frequency without load:	300 min <sup>-1</sup>	
Switching frequency with rated load:	10 min <sup>-1</sup>	
Mechanical life:	1x 10 <sup>7</sup>	
Electrical life AC1:	1x 10 <sup>5</sup>	
<b>Control</b>		
Communication protocol:	RFIO	
Frequency:	866-922 MHz (for more information see p. 80)	
Repeater function:	NO	
Range:	in open space up to 160 m	
<b>Connection</b>		
Network:	max. 2.5 mm <sup>2</sup> / 1.5 mm <sup>2</sup> with sleeve	
<b>Other data</b>		
Relative humidity:	max. 80 %	
Operating temperature:	-15 to +55 °C	
Storing temperature:	-30 to +70 °C	
Protection degree:	IP20	
Overvoltage category:	II.	
Pollution degree:	2	
Operation position:	any	
Installation:	into installation box	
Dimensions:	94 x 94 x 36 mm	
Weight:	161 g	

- Multifunctional RFID card reader RFGCR-31 is part of a comprehensive range of glass control units and can be advantageously used in all projects, e.g. guest room management system.
- The reader sends a wireless command to switch, signaling, bell, etc. This makes it suitable for reconstruction, where the main benefit is the installation speed.
- RFGCR-31 card reader is designed for reading smart cards, which are intended to enter the hotel room or any other part of the building.
- RFGCR-31 supports RFID media with a carrier frequency of 13.56 MHz. Supported card types MIFARE Ultralight, DESFire 2K (EV1), DESFire 4K (EV1).
- The RFGCR-31 is a design component of the system and is available in elegant black (RFGCR-31/B) and white (RFGCR-31/W) variants.
- Input card reader is the first device of guest room management system, with which the hotel guest comes into contact first and therefore was designed with an emphasis on representative design.
- Printing is possible to customize to the investor requirements. The room number as well as the logo of the hotel can be also printed on each component.
- The controller is also equipped with touch button with function of bell and with two icons to indicate the status of guest requests, e.g. "Do Not Disturb" and "Make Up Room".
- Individual symbols can be illuminated in one of seven colours - red, green, blue, yellow, pink, turquoise and white.
- Reader RFGCR-31 is equipped with an 8 A relay output with AgSnO<sub>2</sub> contact for door lock control.
- Reader RFGCR-31 is equipped with a sensor for ambient light intensity. Based on information from the sensor it can e.g. switch the lighting circuits in the corridor.
- Range up to 160 m (in open space), if the signal is insufficient between the card reader and unit, use the signal repeater RFRP-20 or protocol component RFIO2 that support this feature.
- Communication frequency with bidirectional protocol RFIO.
- All versions are in the size of the module (94x94 mm) from the line of luxury switches and sockets LOGUS<sup>90</sup> and are therefore fully in line with the design of frames for the sockets of this series, where you can just as for the controllers choose white and black glass frames.
- RFGCR-31 are designed for mounting into an installation box.

**Connection**

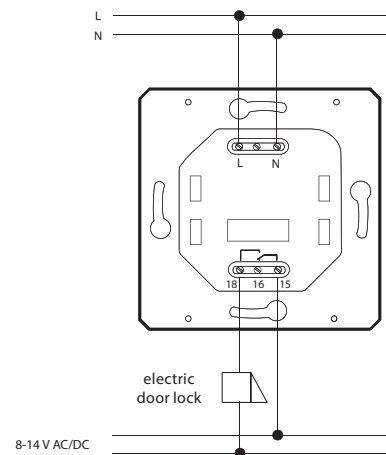

**Device description**

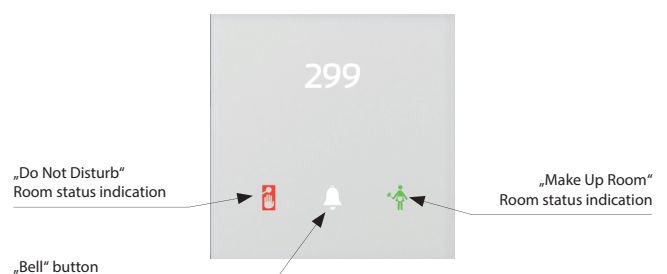



The picture of device is illustrative, the icons (symbols) are configurable by the customer.

Technical parameters	RFGCH-31/W	RFGCH-31/B
Supply voltage:	110 - 230 V AC	
Supply voltage frequency:	50 - 60 Hz	
Dissipated power:	max. 2.5 W	
Apparent input:	max. 5 VA	
<b>Input</b>		
Illuminance sensor:	1 ... 100 000 Lx	
<b>Buttons</b>		
Number of control buttons:	3	
Typ:	capacitive	
Indication:	coloured illuminated symbol	
<b>RFID readers</b>		
Supported frequencies:	13.56 MHz	
Card Type:	MIFARE Ultralight, DESFire 2K (EV1), DESFire 4K (EV1)	
<b>Outputs</b>		
Signalling:	Do Not Disturb, Make Up Room	
Output:	1x switching 10A / AgSnO <sub>2</sub>	
Acoustic output:	piezo-changer	
Tactile output:	Vibration motor	
Switching voltage:	230V AC / 30V DC	
Switching output:	2500 VA / AC1; 300 W/DC	
Insulation voltage between relay outputs and internal circuits:	3.75 kV, SELV dle EN 60950	
Minimal switched current:	10 mA / 10 V	
Switching frequency without load:	300 min <sup>-1</sup>	
Switching frequency with rated load:	10 min <sup>-1</sup>	
Mechanical life:	1x 10 <sup>7</sup>	
Electrical life AC1:	1x 10 <sup>5</sup>	
<b>Control</b>		
Communication protocol:	RFIO	
Frequency:	866–922 MHz (for more information see p. 80)	
Repeater function:	NO	
Range:	in open space up to 160 m	
<b>Connection</b>		
Network:	max. 2.5 mm <sup>2</sup> /1.5 mm <sup>2</sup> with sleeve	
<b>Other data</b>		
Relative humidity:	max. 80 %	
Operating temperature:	-15 to +55 °C	
Storing temperature:	-30 to +70 °C	
Protection degree:	IP20	
Overvoltage category:	II.	
Pollution degree:	2	
Operation position:	any	
Installation:	into installation box	
Dimensions:	142 x 94 x 36 mm	
Weight:	210 g	

- Glass card holder RFGCH-31 is part of a comprehensive range of glass control units for guest room management system.
- The smart card holder sends a wireless command to switch on the alarm, bell, etc This makes it suitable for reconstruction, where the main benefit is the installation speed.
- RFGCH-31 serves for inserting the RFID card into the holder, whereby the system acquires the information about whether the hotel guest is present in the room. With this information it is possible to ensure for example Exit function with relation to energy savings in the absence of a guest in the room.
- Glass card holder is a design component of the system and is available in elegant black (RFGCH-31/B) and white (RFGCH-31/W) version.
- The RFGCH-31 component is equipped with an RFID reader and is thus able to identify the specific hotel card inserted. Power saving function in the absence of a guest cannot be bypassed by simply inserting business cards into the holder.
- RFGCH-31 supports RFID media with a carrier frequency of 13.56 MHz. Supported card types are MIFARE Ultralight, DESFire 2K (EV1), DESFire 4K (EV1).
- The unit is also equipped with three touch buttons that can be used for example to set room status "Do Not Disturb" or "Make Up Room".
- Card holder printing is possible to customize to the investor requirements. The logo of the hotel can be shown for example. Likewise, it is also possible to adapt the card printing.
- The RFGCH-31 unit is equipped with an 10 A relay output and an Ag-SnO<sub>2</sub> contact, which switches the phase conductor.
- Individual symbols can be illuminated in one of seven colours - red, green, blue, yellow, pink, turquoise and white.
- Range up to 160 m (in open space), if the signal is insufficient between the holder and unit, use the signal repeater RFRP-20 or protocol component RFIO2 that support this feature.
- Communication frequency with bidirectional protocol RFIO.
- RFGCH-31 are designed for mounting into an installation box.

### Connection

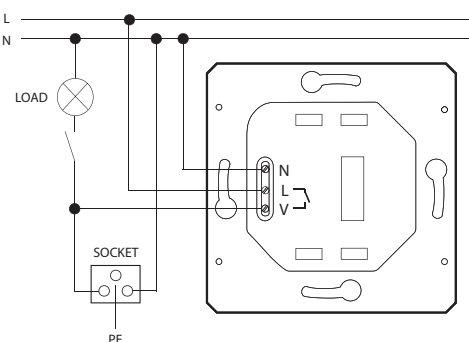

### Device description

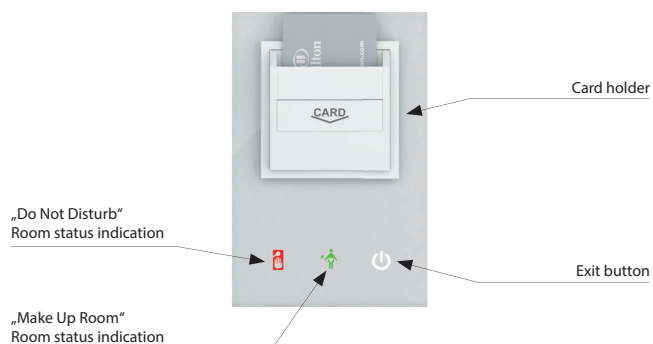

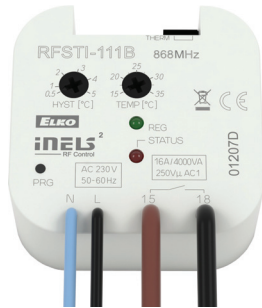

Technical parameters	RFSTI-111B/230V	RFSTI-111B/120V
Supply voltage:	230 V AC	120 V AC
Supply voltage frequency:	50-60 Hz	60 Hz
Apparent input:	9 VA / $\cos \varphi = 0.1$	9 VA / $\cos \varphi = 0.1$ .
Dissipated power:	0.7 W	
Supply voltage tolerance:	+10 %; -15 %	
Temperature measurement input:	1x external TZ/TC temperature sensor input	
Temp. measurement range and accuracy:	+15 to +35 °C; 0.5 °C of the range	
<b>Output</b>		
Number of contacts:	1x switching (AgSnO <sub>2</sub> )	
Rated current:	12 A / AC1	
Switching power:	3000 VA / AC1, 288 W / DC	
Peak current:	30 A / max. 4s at 10%	
Switching voltage:	250 V AC1 / 24 V DC	
Min. switching power:	100 mA / 10 V	
Insulation voltage between relay outputs and internal circuits:	basic insulation (Cat. III surges by EN 60664-1)	
Isolates. voltage open relay contact:	1 kV	
Mechanical service life:	3x10 <sup>7</sup>	
Electrical service life (AC1):	5x10 <sup>4</sup>	
<b>Control</b>		
Communication protocol:	RFIO2	
Frequency:	866-922 MHz (for more information see p. 80)	
Repeater function:	yes	
Range:	in open space up to 160 m	
<b>Other data</b>		
Operating temperature:	-15 to + 50 °C	
Storage temperature:	-30 to + 70 °C	
Indication of relay switch:	red LED	
Indication regulation:	green LED	
Operating position:	any	
Mounting:	free at lead-in wires	
Protection:	IP30	
Overvoltage category:	III.	
Contamination degree:	2	
Outlets (CY wire, cross-section, length):	2 x 0.75 mm <sup>2</sup> , 2 x 2.5 mm <sup>2</sup> , 90 mm	
Dimensions:	49 x 49 x 21 mm	
Weight:	50 g	

Temperature sensor input is at the supply voltage potential.

- The component measures temperature in the range of 15 to 35 °C with external sensor and on the basis of the set temperature switches air conditioning.
- It is particularly suitable for rooms with a tropical climate.
- With the Window/Door sensor programmed, when the window/door is opened, the device relay contact is automatically disconnected, thereby saving unnecessary energy consumed for cooling when the window/door is open.
- It enables connection of the switched load up to 12 A (3000 VA).
- Up to 4 RFDW-100 detectors can be connected to one RFSTI-111B device.
- Range up to 160 m (in open space), if the signal is insufficient between the controller and unit, use the signal repeater RFRP-20 or protocol component RFIO2 that support this feature.
- Communication frequency with protocol RFIO2.
- The BOX design lets you mount it right in an installation box, a ceiling or controlled appliance cover.
- External sensor TC (-20 to +80 °C) or TZ (-40 to +125 °C) for length of 3 m, 6 m, 12 m. For more information see „Accessories“ on page 41.

### Device description

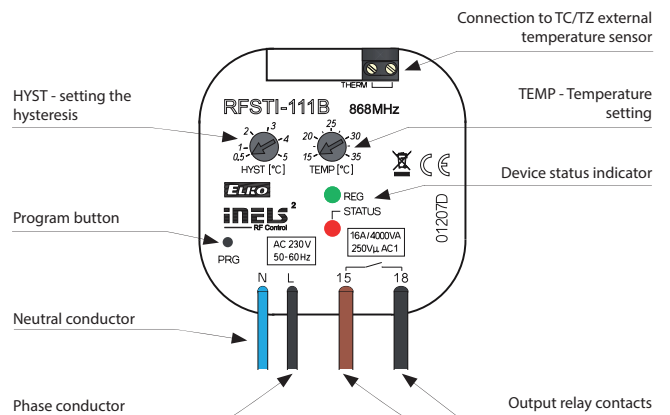

### Function

The external sensor senses the temperature of the room, turns the air conditioner on and off according to the set temperature. Responds to commands from the detector - when you open the window, turn off air conditioning.

### Connection

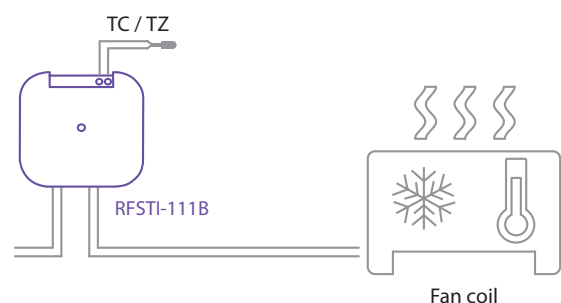



- Switch component with one output channel which is used in combination with detectors for automatic lighting control.
- RFSAI-161B has a pre-set control algorithm (scene) adapted to the requirements of hotel room control, see wiring.
- Each RFSAI-161B can be programmed with 1x RFMD-100, 1x RFWD-100 and 1x wireless controller (RFBW-40/G or RF KEY).
- The terminals on the component give you the opportunity to connect a wired detector or an existing key installation.
- It enables connection of the switched load up to 1x 12 A (3000 VA).
- The programming button on the unit is also used for manual control of the output.
- Range up to 160 m (in open space), if the signal is insufficient between the controller and unit, use the signal repeater RFRP-20 or protocol component RFIO2 that support this feature.
- Communication frequency with bidirectional protocol RFIO2.

### Technical parameters RFSAI-161B /230V RFSAI-161B /120V

Supply voltage:	230 V AC	120 V AC
Supply voltage frequency:	50-60 Hz	60 Hz
Apparent power:	9 VA	9 VA
Dissipated power:	0.7 W	
Supply voltage tolerance:	+10 %; -15 %	

### Output

Number of contacts:	1x switching (AgSnO <sub>2</sub> )
Rated current:	12 A / AC1
Switching power:	3000 VA / AC1, 288 W / DC
Peak current:	30 A, max. 4 s at 10%
Switching voltage:	250 V AC1 / 24 V DC
Min. switching power DC:	100 mA / 10 V
Insulation voltage between outputs and internal circuits:	basic insulation (Cat. III surges by EN 60664-1)
Isolation voltage open contact:	1 kV
Mechanical service life:	3x10 <sup>7</sup>
Electrical service life (AC1):	5x10 <sup>4</sup>
Indication of relay switch:	red LED

### Control

Communication protocol:	RFIO2
Frequency:	866-922 MHz (for more information see p. 80)
Repeater button:	yes
Manual control:	button PROG (ON/OFF)
External button:	cable length max. 12 m <sup>2</sup>
Range:	in open space up to 160 m

### Other data

Open contact voltage external switch:	3 V
Resistor for the management of external switch:	<1 kΩ
Resist. of connection for open contact:	>10 kΩ
Galvanic isolation of input:	no
Operating temperature:	-15 to + 50 °C
Storage temperature:	-30 to + 70 °C
Working position:	any
Mounting:	free at lead-in wires
Protection:	IP30
Overvoltage category:	III.
Contamination degree:	2
Terminals:	0.5 - 1 mm <sup>2</sup>
Terminals (CY wire, Cross-section):	2x 0.75 mm <sup>2</sup> , 2x 2.5 mm <sup>2</sup>
Terminal length:	90 mm
Dimensions:	49 x 49 x 21 mm
Weight:	50 g

Control button input is at the supply voltage potential.

### Device description

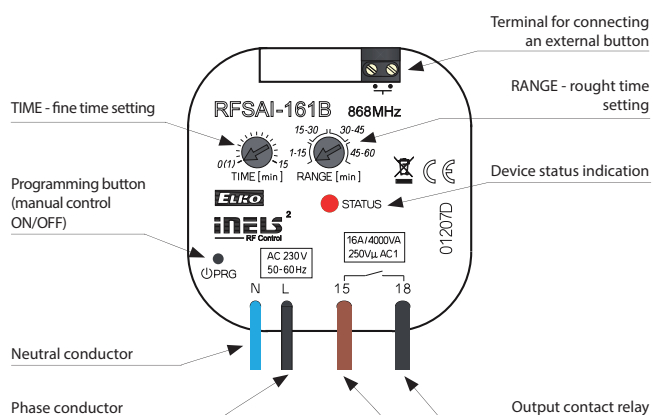

Compatible wireless detectors:  
Movement: RFMD-100  
Door/Window: RFWD-100

### Connection

RFSAI-161B/230V  
RFSAI-161B/120V

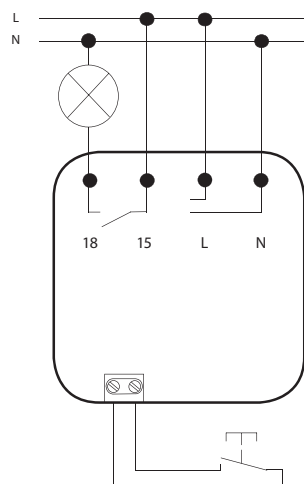



Example

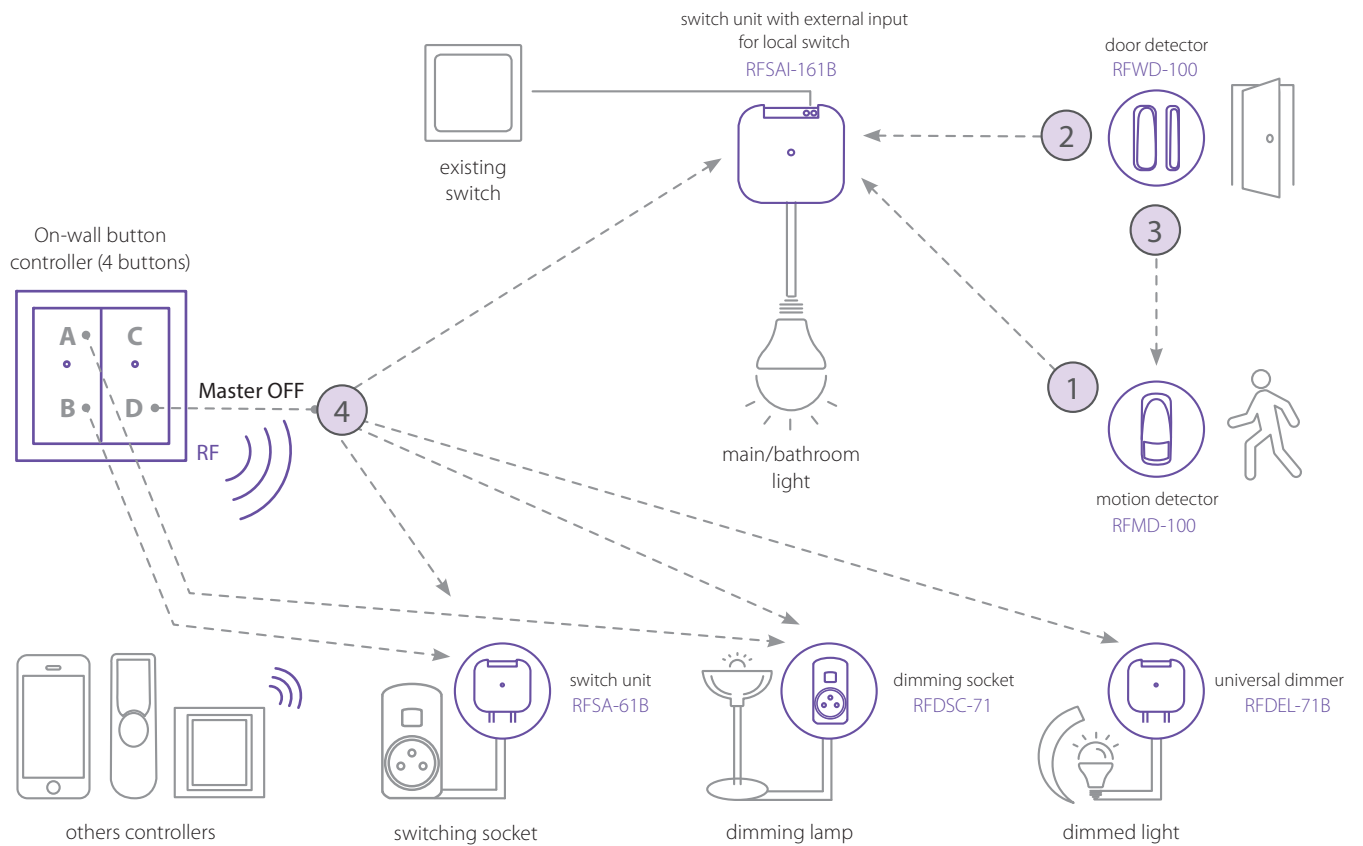

Function

- 1 When RFMD-100 motion detector captures the movement of the guest, the light ON command is sent.
- 2 The functionality of RFWD-100 door detector is delayed OFF = after the guest (or cleaner) close the door than the timer starts running (which you can set) and the light will turn OFF.
- 3 If there is movement the command from RFWD-100 door detector (delay off) will be cancelled by the motion detector RFMD-100 command.
- 4 Pressing the button at position D of RFWB-40 On-wall button controller sends an OFF command to all components that are controlled from that button while blocking the response to RFMD-100 motion detector.
- 5 You are able to control other units with other channels (A, B, C) on RFWB-40 On-wall button controller.
- 6 When guest wakes up and presses any RFWB-40 button, then pressing on button makes all units working again after previous pressing button on position D and it also re-enable RFMD-100 motion detector primary function.



- Thanks to the 6-channel design of the switching component it can control the heating/cooling mode and with 3 speeds, the RE6 output channel can be used to control appliances, sockets or lights.
- The RFSA-166M wireless switching component can be combined with the RFTC-150/G.
- Up to 25 detectors RFWD-100 can be assigned to the switching component.
- The RFWD-100 can be assigned to the RFSA-166M using the PRG button.
- Output Channel RE6:
  - up to 25 channels can be controlled
  - can be combined with detectors, controllers or system components of iNELS RF Control.
  - function: button, pulse relay and delayed start or return time functions with 2 s - 60 min time setting. Function description can be found on page 78.
  - memory status is retained in the event of a power failure.
  - the PRG6 programming button on the component also serves as manual control of the RE6 output.
- The package includes an internal antenna AN-I, in case of locating the element in a metal switchboard, you can use the external antenna AN-E for better signal reception.
- Range up to 100 m (in open space), if the signal is insufficient, use the signal repeater RFRP-20 or protocol component RFIO2 that support this feature.
- Communication frequency with bidirectional protocol RFIO2.

### Technical parameters RFSA-166M/230 V

Supply voltage:	110-230 V AC
Supply voltage frequency:	50-60 Hz
Apparent input:	min. 2 VA / max. 5 VA
Dissipated power:	min. 0.5W / max. 2.5W
Supply voltage tolerance:	+10% / -25 %

### Output

Number of contacts:	3x changeover (AgSnO <sub>2</sub> ); 3x switching (AgSnO <sub>2</sub> )
Rated current:	8 A / AC1
Switching power:	2000 VA / AC1
Peak current:	10 A / <3 s
Switching voltage:	250 V AC1
Max. DC switching power:	500 mW
Mechanical service life:	1x10 <sup>7</sup>
Electrical service life (AC1):	1x10 <sup>5</sup>

### Control

Wireless:	on output RE6 up to 25 channels/buttons
Communication protocol:	RFIO2
Frequency:	866-922 MHz (for more information see p. 80)
Repeater button:	yes
Manual control:	MAN button
Range:	in open space up to 100 m
RF antenna:	AN-I included (SMA connector)*

### Other data

Operating temperature:	-15 °C to + 50 °C
Operating position:	any
Mounting:	DIN rail EN 60715
Protection:	IP20 from the front panel
Overvoltage category:	III.
Contamination degree:	2
Connecting conductor cross-section (mm <sup>2</sup> ):	max. 1x 2.5, max. 2x 1.5 / with a hollow max. 1x 2.5
Dimensions:	90 x 52 x 65 mm
Weight:	264 g
Related standards:	EN 60669, EN 300 220, EN 301 489 R&TTE Directive, Order. No 426/2000 Coll. (Directive 1999/EC)

### Connection for fancoil control

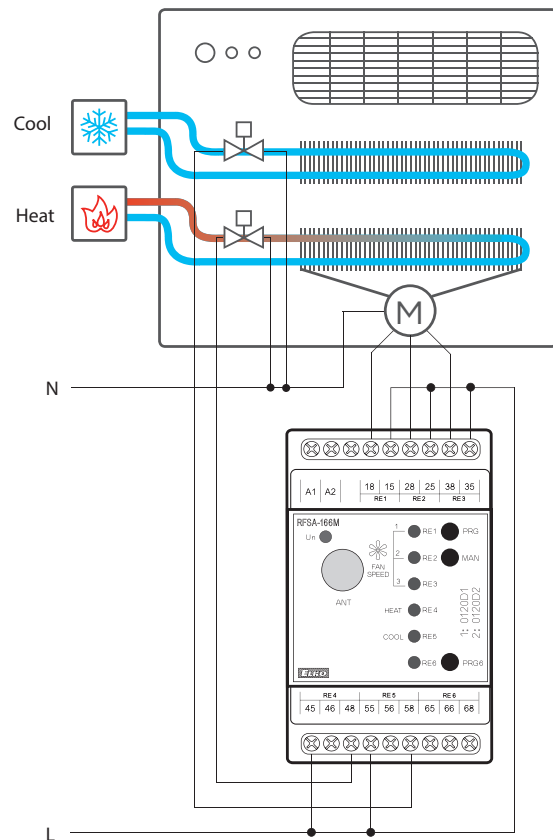

\* Max Tightening Torque for antenna connector is 0.56 Nm.

RFAF/USB | Service Key



- The RFAF/USB Service Key (in conjunction with the RF\_analyzer) is designed for iNELS RF Control system partners and serves for:
  - Setting the repeater (signal amplifier) through the iNELS RF Control elements labeled as RFIO2. This option allows you to communicate over longer distances (in the order of 50 m) via existing iNELS RF Control elements in the installation (eliminating the use of the RFRP-20 repeater).
  - upgrade of firmware in the iNELS RF Control elements (labeled RFIO2), in the case of new firmware versions that improve the functionality of the elements on which we are constantly working.
  - The RF Network Analyzer will reliably analyze the communication between the controller (where you plan to place it) and the component in the installation. Indicates signal strength/quality as well as possible frequencies that can interfere with communication.
  - SW RF analyzer can be found at [inels.com/partners](http://inels.com/partners) in section SW/FW RF Control

Technical parameters	RFAF/USB
Power:	max. 1W
Interface:	USB 1.1 and higher, plug „A“
Range:	100 m
Min. distance of RF Touch-Actuator:	1m
Communication protocol:	RFIO2
Frequency:	866–922 MHz (for more information see p. 80)
Power supply indication:	green LED
RF communication indication:	red LED
<b>Other data</b>	
Operating temperature:	0 to +55°C
Storage temperature:	- 20 to +70°C
Protection:	IP30
Contamination degree:	2
Work space:	any
Installation:	any
Dimensions:	22 x 85 x 15 mm
Weight:	20 g
Related standards:	EN 60950-1

AN-I | Internal antenna



- into plastic switchboard
- rod angle, without cable
- sensitivity 1 dB
- the internal antenna is included in the standard package

AN-E | External antenna



- for mounting into metal switchboard
- cable length 3 m
- sensitivity 5 dB
- the external antenna AN-E is supplied on request only

## Supported video cameras



HIK VISION



D-link



Axis

- Cameras integrated in iHC-MIIRF and iHC-MAIRF applications:  
Axis cameras with PTZ control support.  
HIK VISION cameras with PTZ control support.  
D-Link cameras.  
Other cameras supporting RTSP and MJPEG streams.
- IHC-SMTV supports streaming cameras in JPEG format.

## Supported intercoms



- The iHC-MAIRF/iHC-MIIRF applications are integrated as client accounts for the SIP server on the Connection Server (Asterisk) and the SIP server on the Dahua speaker.
- Using CS, it is possible to freely connect applications with LARA Intercom, 2N and HIK VISION voices.



**Basic sets**

**RFSET-SW2-Z1**



1x Wireless switch unit  
RFSA-11B

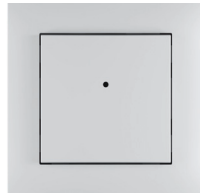

1x Wireless wall controller  
RFWB-20/G - white

EAN: 8595188138901

**RFSET-SK-Z1**



1x Wireless switch unit  
RFSA-11B



1x Keychain  
RF Key/B - black

EAN: 8595188138741

**Multifunction sets**

**RFSET-SW-F1**



1x Wireless switch unit  
RFSA-61B

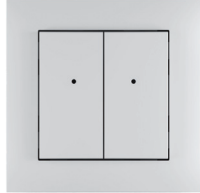

1x Wireless wall controller  
RFWB-40/G - white

EAN: 8595188138772

**RFSET-SK-F1**



1x Wireless switch unit  
RFSA-61B



1x Keychain  
RF Key/B - black

EAN: 8595188138789

**RFSET-SMK-F1**



1x Wireless switch unit RFSA-61M  
with external antenna A-NI



1x Keychain  
RF Key/B - black

EAN: 8595188138895

## Single function - RFSA-11B

## Function button ON/OFF

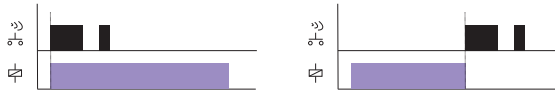

The output contact closes by pressing one button position, and opens by pressing the other button position.

## Multi function - RFSA-61B, RFSA-62B, RFSA-61M, RFSA-66M, RFSAI-61B, RFSAI-62B, RFSC-61, RFUS-61

## Function 1 - button



The output contact will be closed by pressing the button and opened by releasing the button.

## Function 2 - switch on



The output contact will be closed by pressing the button.

## Function 3 - switch off



The output contact will be opened by pressing the button.

## Function 4 - impulse relay

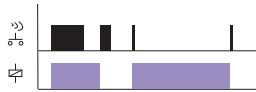

The output contact will be switched to the opposite position by each press of the button. If the contact was closed, it will be opened and vice versa.

## Function 5 - delayed off

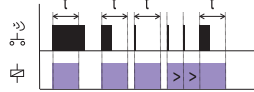

The output contact will be closed by pressing the button and opened after the set time interval has elapsed.  
 $t = 2 \text{ s} \dots 60 \text{ min.}$

## Function 6 - delayed on

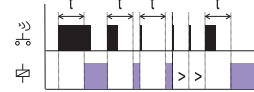

The output contact will be opened by pressing the button and closed after the set time interval has elapsed.  
 $t = 2 \text{ s} \dots 60 \text{ min.}$

## Loadability products

## RFJA-32B; RFSA-62B; RFSAI-62B; RFSA-66M

Load type	$\cos \varphi \geq 0.95$								
Contact material AgSnO <sub>2</sub> , Contact 8 A	AC1	AC2	AC3	AC5a without compensation	AC5a with compensation	AC5b	AC6a	AC7b	AC12
	250 V / 8 A	250 V / 5 A	250 V / 4 A	x	x	250 W	250 V / 4 A	250 V / 1 A	250 V / 1 A
Load type									
Contact material AgSnO <sub>2</sub> , Contact 8 A	AC13	AC14	AC15	DC1	DC3	DC5	DC12	DC13	DC14
	x	250 V / 4 A	250 V / 3 A	30 V / 8 A	24 V / 3 A	30 V / 2 A	30 V / 8 A	30 V / 2 A	x

## RFUS-61

Load type	$\cos \varphi \geq 0.95$								
Contact material AgSnO <sub>2</sub> , Contact 14 A	AC1	AC2	AC3	AC5a without compensation 230 V / 3 A (690 VA)	AC5a with compensation 230 V / 3 A (690VA) up to max input C=14uF	AC5b	AC6a	AC7b	AC12
	250 V / 12 A	250 V / 5 A	250 V / 3 A	230 V / 3 A (690 VA)	230 V / 3 A (690VA) up to max input C=14uF	1000 W	x	250 V / 3 A	x
Load type									
Contact material AgSnO <sub>2</sub> , Contact 14 A	AC13	AC14	AC15	DC1	DC3	DC5	DC12	DC13	DC14
	x	250 V / 6 A	250 V / 6 A	24 V / 10 A	24 V / 3 A	24 V / 2 A	24 V / 6 A	24 V / 2 A	x

## RFSA-11B; RFSA-61B; RFSA-61M; RFSC-61; RFSTI-11B; RFDAC-71B

Load type	$\cos \varphi \geq 0.95$								
Contact material AgSnO <sub>2</sub> , Contact 16 A	AC1	AC2	AC3	AC5a without compensation 230 V / 3 A (690 VA)	AC5a with compensation 230 V / 3 A (690VA) up to max input C=14uF	AC5b	AC6a	AC7b	AC12
	250 V / 16 A	250 V / 5 A	250 V / 3 A	230 V / 3 A (690 VA)	230 V / 3 A (690VA) up to max input C=14uF	1000 W	x	250 V / 3 A	250 V / 10 A
Load type									
Contact material AgSnO <sub>2</sub> , Contact 16 A	AC13	AC14	AC15	DC1	DC3	DC5	DC12	DC13	DC14
	x	250 V / 6 A	250 V / 6 A	24 V / 10 A	24 V / 3 A	24 V / 2 A	24 V / 6 A	24 V / 2 A	x

Multi-function RFDA-73M/RGB, RFDEL-71B, RFDEL-71M, RFDSC-71, RFDAC-71B, RFDW-71

Light scene function 1

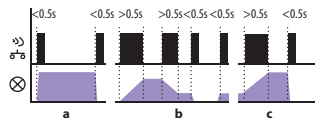

- a) By pressing the programmed button for less than 0.5 s, the light illuminates; it goes out by pressing again.
  - b) By pressing the programmed button for more than 0.5 s, fluid brightness regulation will occur. After releasing the button, the brightness level is saved in the memory, and pressing the button shortly later will switch the light on/off to this intensity.
  - c) It is possible to readjust the change in intensity at any time by a long press of the programmed button.
- The actuator remembers the adjusted value even after disconnecting from the power supply.

Light scene function 3

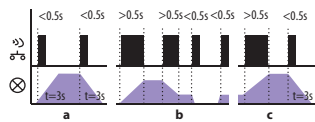

- a) By pressing the programmed button for less than 0.5 s, the light fluidly illuminates for a period of 3 s (at 100% brightness). By pressing the button shortly again, the light will continuously switch off for 3 seconds.
  - b) By pressing the programmed button for more than 0.5 s, fluid brightness regulation will occur. After releasing the button, the brightness level is saved in the memory, and pressing the button shortly later will switch the light on/off to this intensity.
  - c) It is possible to readjust the change in intensity at any time by a long press of the programmed button.
- The actuator remembers the adjusted value even after disconnecting from the power supply.

Function sunrise

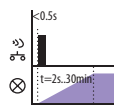

After pressing the programmed button, the light begins to illuminate in the programmed time interval in a range of 2 seconds to 30 minutes.

Function ON/OFF

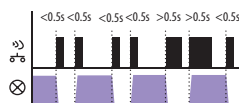

If the light is switched off, pressing the programmed button will switch it on. If the light is switched on, pressing the programmed button will switch it off.

Light scene function 2

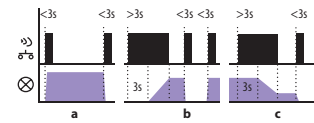

- a) By pressing the programmed button for less than 3 s, the light illuminates; it goes out by pressing again.
  - b) In order to limit undesirable control of brightness, fluid brightness control occurs only by pressing a programmed button for over 3 s. After releasing the button, the brightness level is saved in the memory, and pressing the button shortly later will switch the light on/off to this intensity.
  - c) It is possible to readjust the change in intensity at any time by pressing the programmed button for over 3 s.
- The actuator remembers the adjusted value even after disconnecting from the power supply.

Light scene function 4

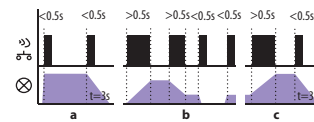

- a) By pressing the programmed button for less than 0.5 s, the light illuminates. By pressing the button shortly again, the light will continuously switch off for 3 seconds (at 100% brightness).
  - b) By pressing the programmed button for more than 0.5 s, fluid brightness regulation will occur. After releasing the button, the brightness level is saved in the memory, and pressing the button shortly later will switch the light on/off to this intensity.
  - c) It is possible to readjust the change in intensity at any time by a long press of the programmed button.
- The actuator remembers the adjusted value even after disconnecting from the power supply.

Function sunset

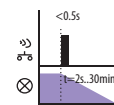

After pressing the programmed button, the light begins to dim in the programmed time interval in a range of 2 seconds to 30 minutes.

Function switch off

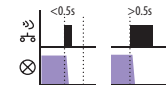

The dimmer output switches off by pressing the button.

Rating of the light source ELKO lighting on dimmers ELKO EP

	LED bulb		LED spot lights			LED panels		LED / RGB strip					
	DLB-E27-806-2K7	DLB-E27-806-5K	DLSL-GU10-350-3K	LSL-GU10-350-3K	LSL-GU10-350-5K	LP-6060-3K	LP-6060-6K	LED strip 7.2W	LED strip 14.4W	LED strip 19.2W	LED strip 28.8W	RGB strip 7.2W	RGB strip 14.4W
RFDSC-71	✓ 21	✓ 21	✓ 45	✓ 25	✓ -	-	-	-	-	-	-	-	-
RFDEL-71B	✓ 11	✓ 11	✓ 25	✓ 13	✓ 13	-	-	-	-	-	-	-	-
RFDA-73M/RGB	-	-	-	-	-	-	-	✓ 3x8m	✓ 3x4m	✓ 3x5m	✓ 3x4m	✓ 20m	✓ 10m
RFDAC-71B	-	-	-	-	-	✓ 50	✓ 50	-	-	-	-	-	-

WARNING!

May lead to different results based on the state of network cable length and other factors.

This table contains the results of tests that were conducted internally and therefore is ONLY for customers only informative. The products were tested in test laboratories ELKO EP, and therefore the company assumes no responsibility for any imitation test environment.

**Inductive and capacitive loads must not be connected simultaneously!**

Load capacity:

\* Due to the huge amount of type of light sources, the maximum load depends on internal construction of dimmable LED and ESL bulbs and their power factor cos φ, capacity for power factor cos φ=1. The power factor of dimmable LEDs and ESL bulbs ranges from cos φ = 0.95 up to 0.4. An approximate value of maximum load may be obtained by multiplying the load capacity of the dimmer by the power factor of the connected light source.

The communication between the components is wireless at 866–922 MHz (according to country standards/regulations), using the unique RFIO and RFIO2 protocols. Both are proprietary wireless protocols from ELKO EP, which have a completely unique structure. RFIO2 is an extension of the RFIO protocol and allows users to use newly introduced features, such as unit signals (repeater), for selected features. This protocol is fully compatible with the previous version of the protocol (RFIO).

#### Available frequency for individual territories:

**865.15 MHz** India

**868.1 MHz** Russia

**868.5 MHz** EU, Ukraine, Middle East

**916 MHz** Australia, New Zealand, America, Israel

#### Benefits of RFIO:

- Communication is low-energy and reliably transfers small data packets.
- Fees or licenses are not required.
- No overlapping of communication space with unaddressed commands.
- Frequency used does not interfere with Wi-Fi/Bluetooth devices.
- Setting communication between components is not conditional on working with a computer or system.

#### Benefits of RFIO2:

- Products labeled as “RFIO2” will allow newly set selected components such as unit signals (repeaters).
- For components, you can easily update FW using the RFAF/USB service device.
- Enables communication with RFMD-100, RFWD-100 and RFSD-100 / RFSD-101.
- Data transfer between wireless components takes place in such a way that other receivers within range can help transfer the information (packet) to a remote receiver that is out of reach. It is possible to cover large-scale objects (real estate) and also increase the reliability of transmission in more demanding buildings.
- Backward compatibility with RFIO elements is retained.





**1) Surface mounted**

Wall mounted or in an installation box with spacing of 65 mm.

RF Touch-W	RFTC-10/G
RFWB-20/G	RFTC-50/G
RFWB-40/G	RFTC-150/G
RFGB-20	RFGB-220
RFGB-40	RFGB-240

**2) Flush mounted**

RF Touch-B	RFGCR-31
RFDW-71	RFGCH-31
RFPCR-31/G	
RFDW-271	

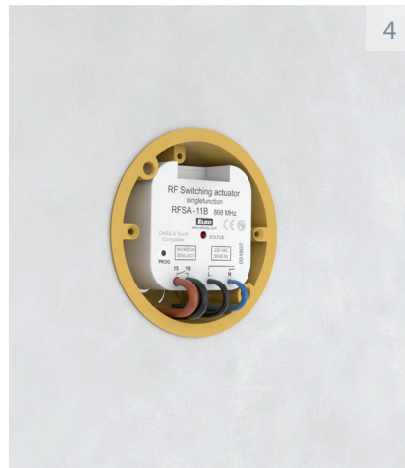
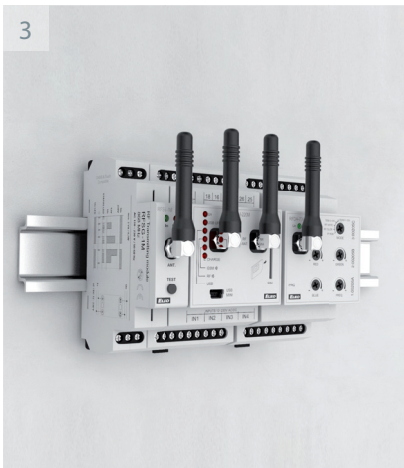

**3) DIN Rail mounted**

On DIN rail according to EN 60715.

RFSG-1M	RFDEL-71M
RFPM-2M	RFSA-61M
RFDA-73M/RGB	RFSA-66M
	RFSA-166M

**4) Mounted to or in the installation box**

RFIM-20B	RFSAI-62B
RFIM-40B	RFJA-32B
RFDAC-71B	RFSF-1B
RFDEL-71B	RFSTI-11B
RFSA-11B	RFTI-10B
RFSA-61B	RFSAI-161B
RFSA-62B	RFSTI-111B



**5) Mounted into the cover of appliance**

RFDAC-71B	RFJA-32B
RFDEL-71B	RFSAI-161B
RFSA-11B	RFSTI-111B
RFSA-61B	
RFSA-62B	

**6) Surface mounted**

RFSOU-1	RFSD-100
RFUS-61	RFSD-101
RFTM-1	RFMD-100
RFSF-1B	RFWD-100

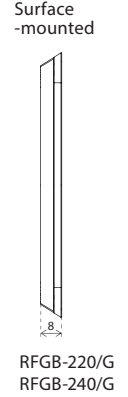
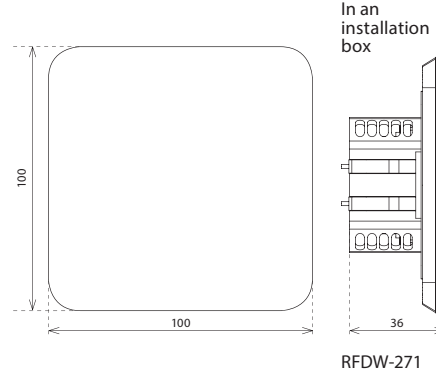
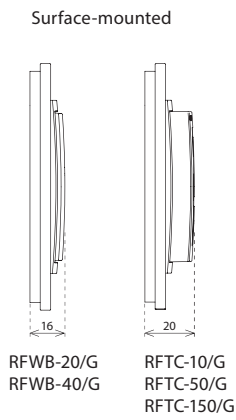
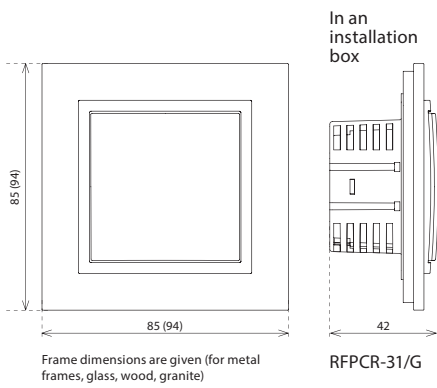
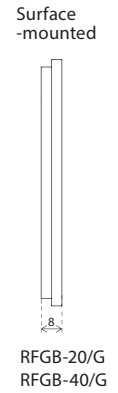
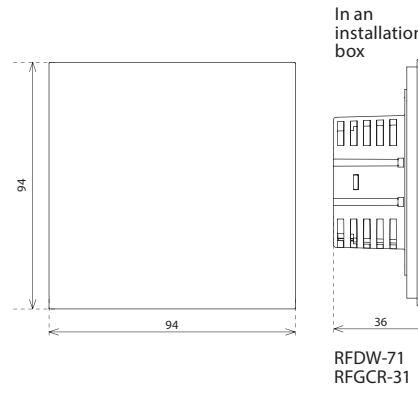
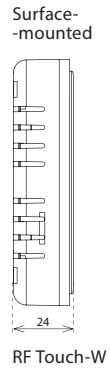
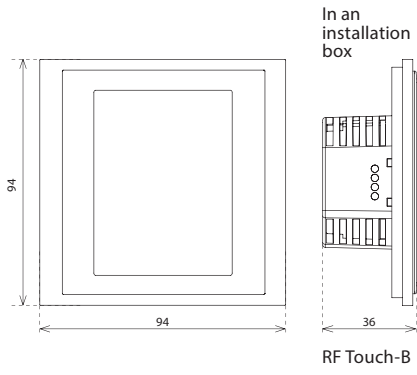

1Modul

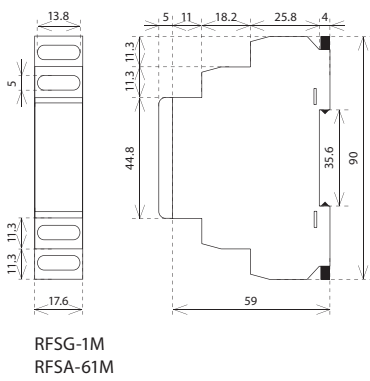

3Modul

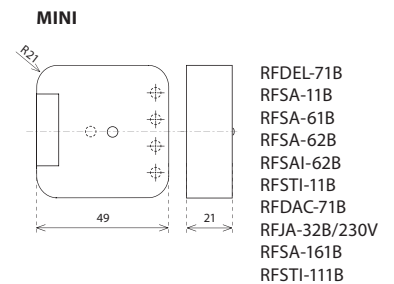
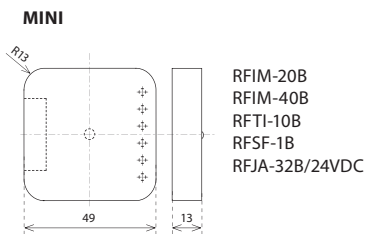
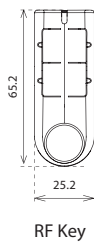
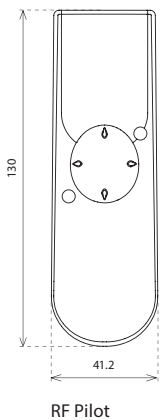
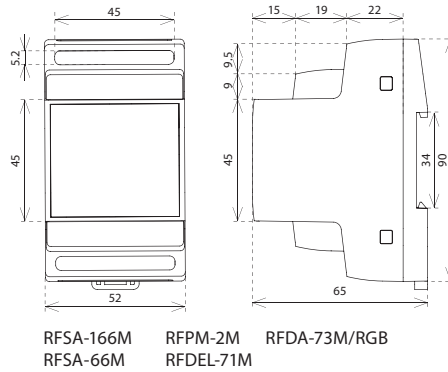

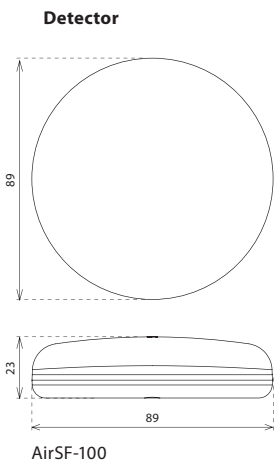
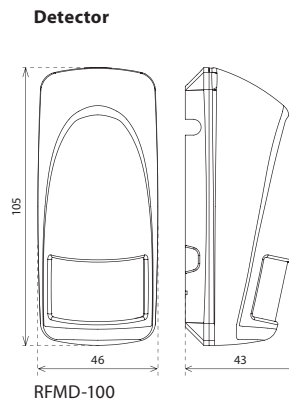
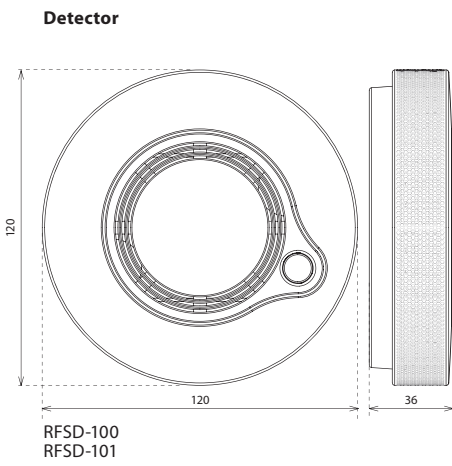
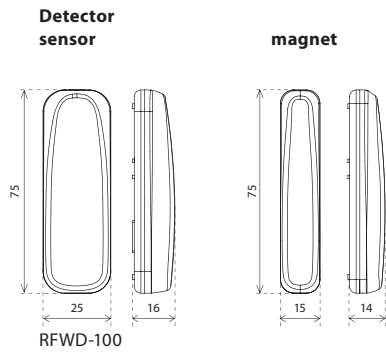
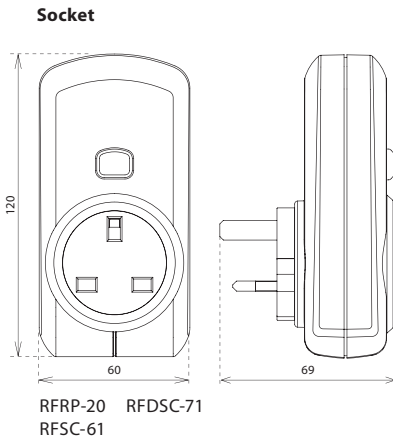
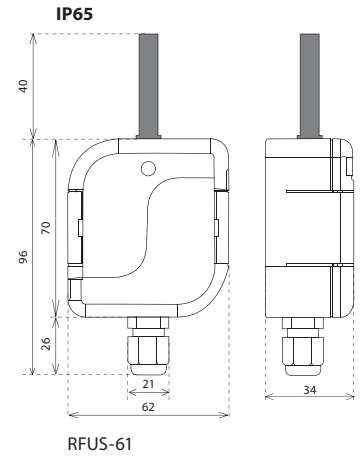
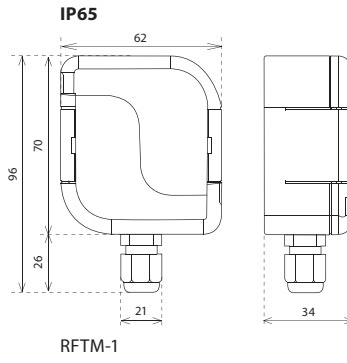
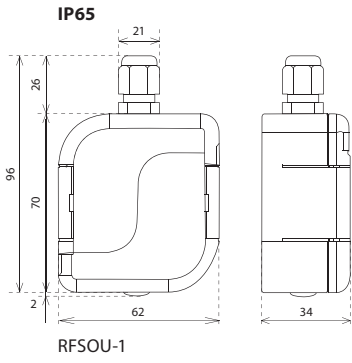

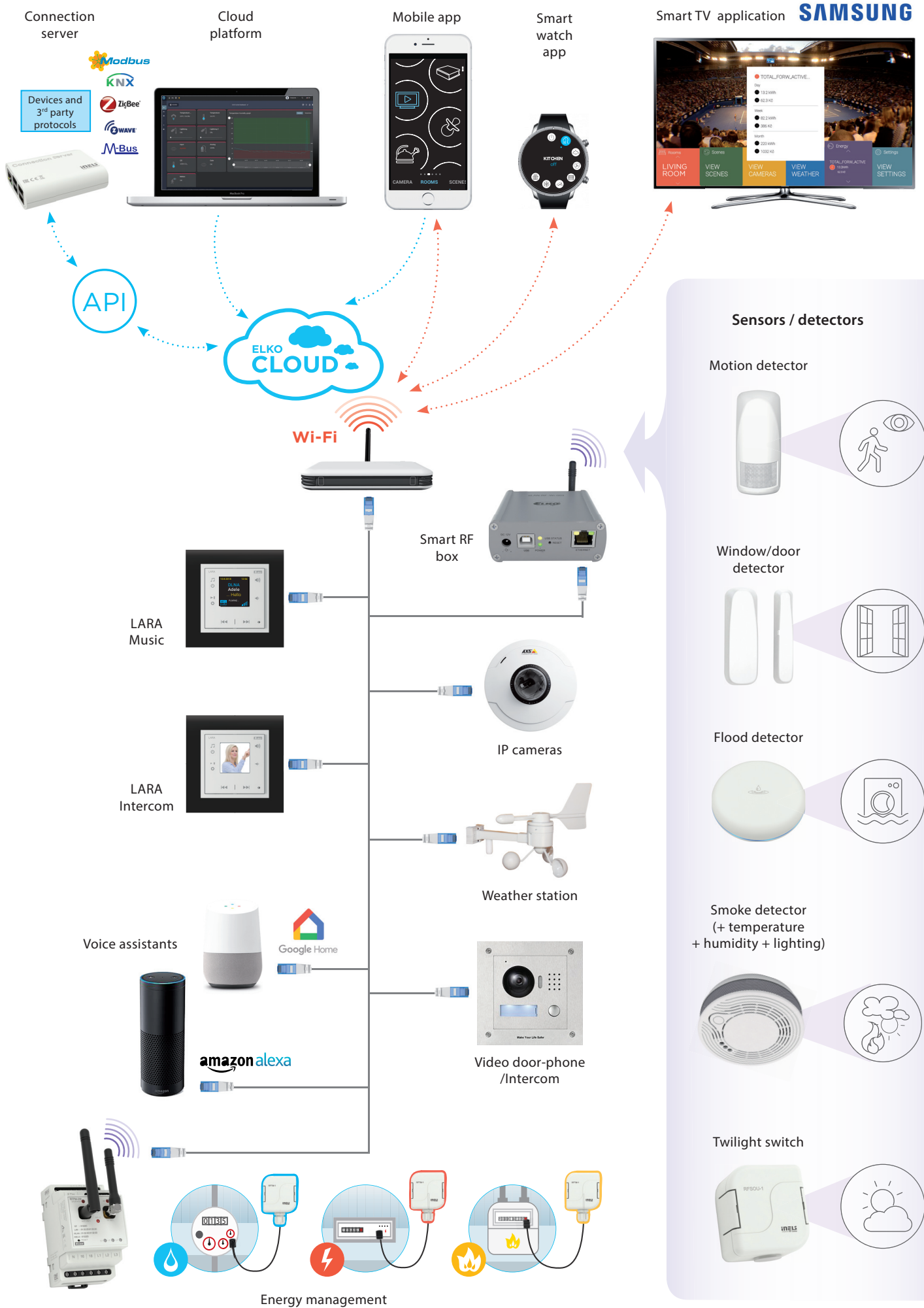

Actuators



Switching socket

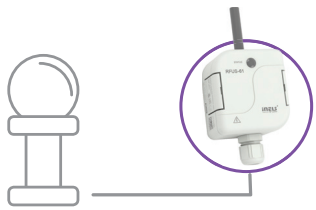

Switch unit (outdoor)



Universal dimmer R L C LED ESL



Switch unit for shutters

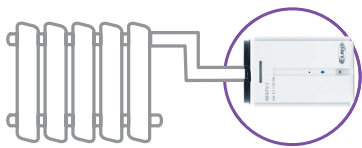

Thermovalve



Switch unit 6 channel



Analog controller 0-10 V

Controllers



Wall button

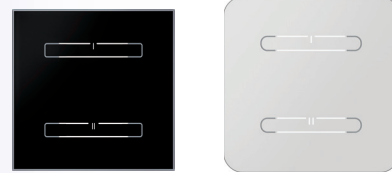

Touch glass



Touch glass with dimmer



Keychain

RF Pilot with display



Contact converter



Wireless touch unit



Temperature controller

## Product groups of the Wireless electro-installation



Controllers



Switching units



Dimmers

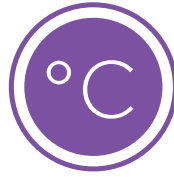

Temperature control



Converters



Detectors



Frequency	EAN	Type	Supply voltage
868.5 MHz	8595188140379	RFWB-20/G	CR 2032
868.5 MHz	8595188140607	RFWB-40/G	CR 2032
868.5 MHz	8595188176781	RFGB-20/W	2x CR 2032
868.5 MHz	8595188176798	RFGB-20/B	2x CR 2032
868.5 MHz	8595188176804	RFGB-40/W	2x CR 2032
868.5 MHz	8595188176811	RFGB-40/B	2x CR 2032
868.5 MHz	8595188159838	RFDW-71/230V/W	230 V AC
868.5 MHz	8595188141789	RFDW-71/230V/B	230 V AC
916 MHz	8595188159852	RFDW-71/120V/W	120 V AC
916 MHz	8595188144223	RFDW-71/120V/B	120 V AC
868.5 MHz	8595188143332	RF KEY/W	CR 2032
868.5 MHz	8595188143752	RF KEY/B	CR 2032
868.5 MHz	8595188143769	RF Pilot/W	2x 1,5 V AAA
868.5 MHz	8595188145169	RF Pilot/A	2x 1,5 V AAA
868.5 MHz	8595188143738	RF Touch-B	100 - 230 V
868.5 MHz	8595188131711	RF Touch-W	100-230V/120DC
868.5 MHz	8595188145107	RFRP-20 - French	230 - 250 V
868.5 MHz	8595188145473	RFRP-20 - Schuko	230 - 250 V
868.5 MHz	8595188145480	RFRP-20 - British	230 - 250 V
910 MHz	8595188135706	RFRP-20 - French	120 V
868.5 MHz	8595188146845	eLAN-RF-003	10 - 27 V DC / 230 m A SELV
868.5 MHz	8595188151788	RFPM-2M	230 V AC
868.5 MHz	8595188143158	RFTM-1	2x 1,5 AAA
	8595188155908	CT50	
	8595188155762	LS	
	8595188155779	MS	
	8595188157940	WS	
868.5 MHz	8595188136839	RFSA-11B / 230 V	230 V AC
916 MHz	8595188151436	RFSA-11B / 120 V	120 V AC
868.5 MHz	8595188151399	RFSA-11B / 24 V	12-24 V AC / DC

Frequency	EAN	Type	Supply voltage
868.5 MHz	8595188136242	RFSA-61B / 230 V	230 V AC
916 MHz	8595188151504	RFSA-61B / 120 V	120 V AC
868.5 MHz	8595188151467	RFSA-61B / 24 V	12-24 V AC / DC
868.5 MHz	8595188142816	RFSA-62B / 230 V	230 V AC
916 MHz	8595188151832	RFSA-62B / 120 V	120 V AC
868.5 MHz	8595188151894	RFSA-62B / 24 V	12 - 24 V AC/DC
868.5 MHz	8595188149990	RFSAI-62B / 230 V	230 V AC
916 MHz	8595188174947	RFSAI-62B / 120 V	120 V AC
868.5 MHz	8595188137003	RFSA-61M	110 - 230 V AC
868.5 MHz	8595188142823	RFSA-66M	110 - 230 V AC
868.5 MHz	8595188152914	RFSA-66M	12-24 V AC / DC
868.5 MHz	8595188145268	RFUS-61	230 V AC
916 MHz	8595188152570	RFUS-61	120 V AC
868.5 MHz	8595188145602	RFSC-61 - French	230 - 250 V
868.5 MHz	8595188145626	RFSC-61 - Schuko	230 - 250 V
868.5 MHz	8595188145442	RFSC-61 - British	230 - 250 V
916 MHz	8595188153744	RFSC-61/120V - French	120 V
868.5 MHz	8595188174664	RFJA-32B / 230 V	230 V AC
916 MHz	8595188174923	RFJA-32B / 120 V	120 V AC
868.5 MHz	8595188157681	RFJA-32B / 24 V DC	5 - 24 V DC
868.5 MHz	8595188142809	RFDAC-71B	110 - 230 V AC
868.5 MHz	8595188145121	RFDEL-71B / 230 V	230V
868.5 MHz	8595188152228	RFDEL-71B / 120 V	120 V
868.5 MHz	8595188148979	RFDEL-71M / 230 V	230V
868.5 MHz	8595188153041	RFDEL-71M / 120 V	120 V
868.5 MHz	8595188146814	RFDA-73M/RGB	12 - 24 V DC

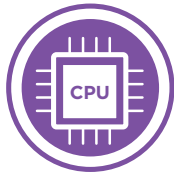

System units



Energy management



Hotel Retrofit



RF sets



Lighting



Accessories

Frequency	EAN	Type	Supply voltage
868.5 MHz	8595188145947	RFSDC-71 - French	230 -250 V
868.5 MHz	8595188145954	RFSDC-71 - Schuko	230 -250 V
868.5 MHz	8595188145466	RFSDC-71 - British	230 -250 V
916 MHz	8595188153782	RFSDC-71/ 120V - French	120 V
868.5 MHz	8595188135849	RFSTI-11B / 230 V	230 V AC
868.5 MHz	8595188152396	RFSTI-11B / 120 V	120 V AC
868.5 MHz	8595188152419	RFSTI-11B / 24 V	12 - 24 V AC/DC
868.5 MHz	8595188131759	RFTI-10B	CR 2477
	8595188110075	TC-0	
	8595188110617	TC-3	
	8595188110082	TC-6	
	8595188110099	TC-12	
	8595188140591	TZ-0	
	8595188110600	TZ-3	
	8595188110594	TZ-6	
	8595188110587	TZ-12	
868.5 MHz	8595188142861	RFTC-10/G	2x 1,5 V AAA
868.5 MHz	8595188148641	RFTC-50/G	2x 1,5 V AAA
868.5 MHz	8595188145138	RFATV-1	2x 1,5 V AAA
	8595188166010	TELVA 230V, NC	+ adapter VA80
	8595188166027	TELVA /230V, NO	+ adapter VA80
	8595188166034	TELVA 24V, NC	+ adapter VA80
	8595188166041	TELVA 24V, NO	+ adapter VA80
868.5 MHz	8595188139274	RFIM-20B	CR 2477
868.5 MHz	8595188137188	RFIM-40B	2x CR 2032
868.5 MHz	8595188142847	RFSG-1M	110 - 230 V AC

Frequency	EAN	Type	Supply voltage
868.5 MHz	8595188148603	RFSF-1B	CR 2477
868.5 MHz	8595188150095	RFSF-1B+FP-1	CR 2477
	8595188147064	FP-1	
868.5 MHz	8595188176828	RFSF-100	2x 1,5 V AAA
868.5 MHz	8595188147071	RFSOU-1	2x 1,5 V AAA
868.5 MHz	8595188150286	RFSD-100	4x 1,5 V AA
868.5 MHz	8595188159630	RFSD-101	4x 1,5 V AA
868.5 MHz	8595188150279	RFWD-100	2x 1,5 V AA
868.5 MHz	8595188150293	RFMD-100	CR 2032
868.5 MHz	8595188134576	RFTC-150/G	2x 1,5 V AAA
868.5 MHz	8595188134323	RFSAI-166M / 230 V	110 - 230 V AC
868.5 MHz	8595188149150	RFSTI-111B / 230V	230 V
868.5 MHz	8595188134095	RFSTI-111B / 120V	120 V
868.5 MHz	8595188149341	RFSAI-161B / 230V	230 V
868.5 MHz	8595188134040	RFSAI-161B / 120 V	120 V
868.5 MHz	8595188174572	RFCPR-31/G	110 - 230 V AC
868.5 MHz	8595188174589	RFGCR-31/W	110 - 230 V AC
868.5 MHz	8595188174596	RFGCR-31/B	110 - 230 V AC
868.5 MHz	8595188174602	RFGCH-31/W	110 - 230 V AC
868.5 MHz	8595188174619	RFGCH-31/B	110 - 230 V AC
868.5 MHz	8595188145039	RFAF/USB	
	8595188161862	AN-I	
	8595188190121	AN-E	

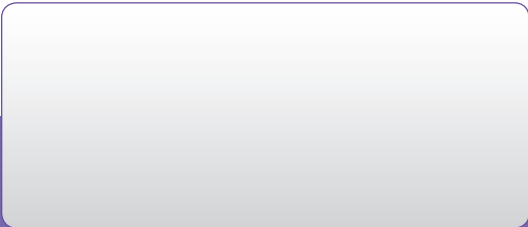
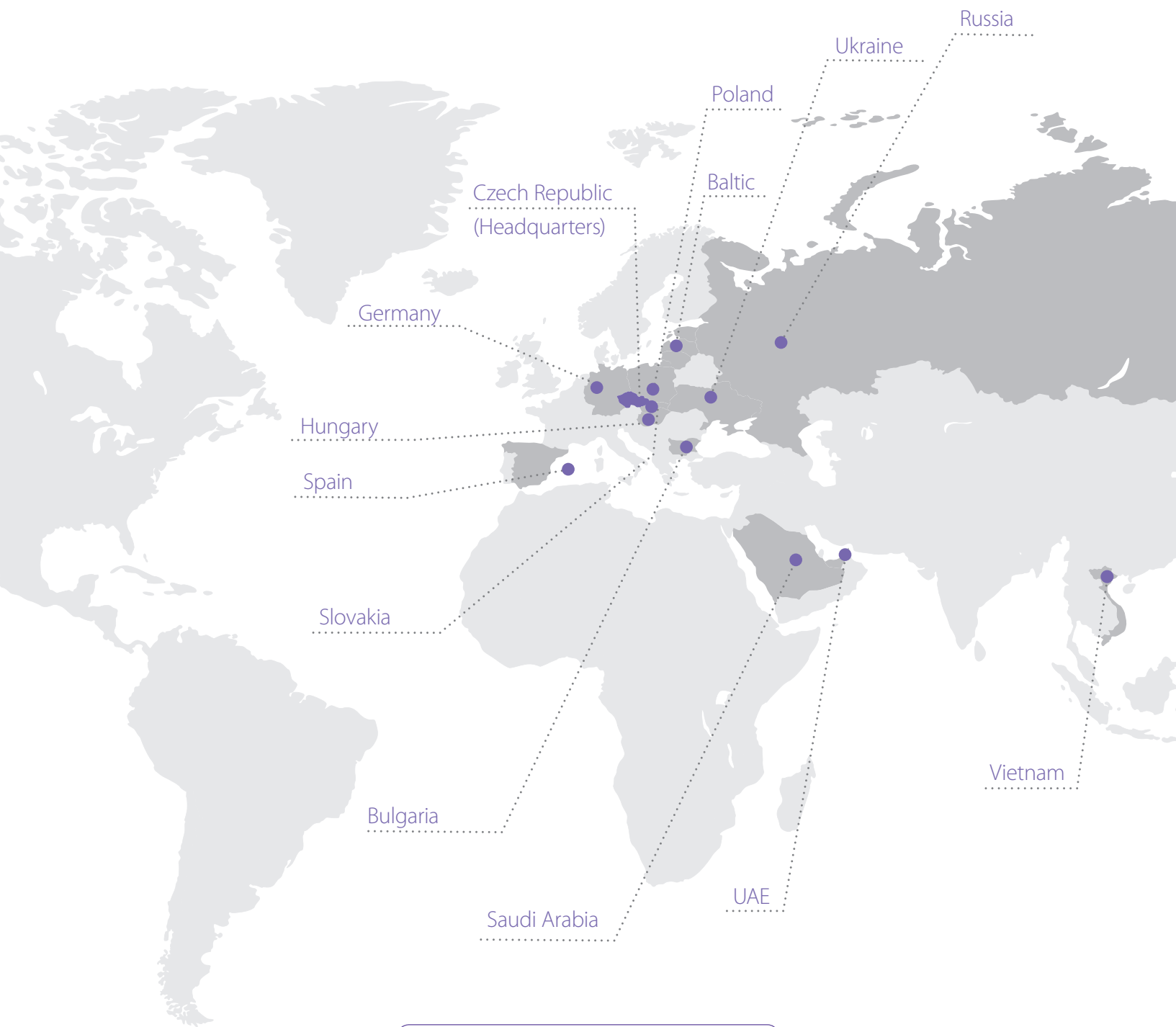

**ELKO EP, s.r.o.**

Palackeho 493 | 769 01 Holesov, Vsetuly | Czech Republic  
phone: +420 573 514 221 | fax: +420 573 514 227 | [elko@elkoep.com](mailto:elko@elkoep.com) | [www.elkoep.com](http://www.elkoep.com)

Published: 5/2020 | Modifications or amendments reserved | © Copyright ELKO EP, s.r.o. | 1st edition